



Remote Camera

User Manual

CR-X300

Table of Contents

	Introduction.....	6
	Safety Precautions and Handling Instructions (Disclaimer)	6
	Trademarks	9
	Software License Agreement.....	9
	Third Party Software.....	9
	User Manuals.....	11
	Types of User Manuals	11
	How to Use This Document	11
	Names of Parts	12
	Receptacle Unit	13
	Related Software	16
	Camera Search Tool	16
	Remote Camera Control Application	16
	Examples of System Configuration.....	17
Chapter 1	Installation and Connection	
	Installation.....	20
	Carrying the Product.....	20
	Mounting the Head Unit.....	20
	Using a Tripod	21
	Attaching the Connector Cover	21
	Routine Maintenance.....	23
	Confirmation of Video Image	23
	Cleaning Method.....	23
Chapter 2	Default Settings	
	Security Checking/Settings	25
	Checking the Firewall Settings (Windows).....	25
	Initial Camera Settings.....	26
	Settings Using the Camera Search Tool.....	26
	Camera's Settings Page from the Web Browser.....	28
Chapter 3	Camera Setup	
	Overview.....	30
	Accessing from a Web Browser	30
	Configuration of the Settings Page	31
	Camera Operation	33
	Operation by Clicking on the Video Display Area or by Slider	33
	Exposure Settings.....	35
	WB/Color Settings.....	40
	Image Quality Settings	42
	Image Quality Details Settings	43

Focus Settings	45
Autofocus	45
Manual Focus.....	47
PTZ/IS Settings	48
Preset Settings.....	49
Registering Presets.....	49
Calling Presets	50
Deleting Presets.....	50
Other Functions Settings	51
System Settings	52
Screen Configuration	52
Setting Items	53
Common Operations.....	53
[System] > [Video and Audio] > [HDMI/SDI]	55
HDMI/SDI	55
SDI	55
[System] > [Video and Audio] > [IP Streaming Video].....	56
Mainstream	56
Substream 1.....	57
Substream 2.....	57
[System] > [Video and Audio] > [Audio].....	58
General audio	58
IP Audio Streaming	58
[System] > [Server] > [HTTP/Video].....	59
HTTP Server	59
Video Server.....	59
[System] > [Server] > [RTP].....	60
RTP Server	60
Audio Settings.....	60
RTP Mainstream, RTP Substream 1, RTP Substream 2.....	61
[System] > [Communication] > [Network].....	62
LAN	62
IPv4	62
IPv6	63
DNS.....	63
mDNS.....	64
[System] > [Communication] > [External Connection (IP)].....	65
Standard Communication (IP).....	65
NDI HX	65
RTMP.....	66
[System] > [Communication] > [External Connection (Serial)]	67
Serial Port.....	67
Standard Communication (Serial).....	68
[System] > [Security] > [Certificate Management]	69
Server Certificate Management	69
Create Certificate	69

[System] > [Security] > [SSL/TLS]	70
Encrypted Communications.....	70
Server Certificates.....	70
[System] > [Security] > [User Management]	71
Administrator Account	72
Authorized User Account.....	72
User Authority	72
[System] > [Security] > [Host Access Restrictions].....	73
IPv4 Host Access Restrictions	73
IPv6 Host Access Restrictions	73
[System] > [System] > [Camera]	75
Camera Name.....	75
Installation Conditions.....	75
Camera Control.....	75
Color Bars	76
AUX OUT.....	76
Tally Lamp.....	76
Genlock.....	76
[System] > [System] > [Date and Time].....	77
Current Date and Time.....	77
Settings	77
[System] > [System] > [Environment]	79
Environment	79
[System] > [System] > [Language]	80
Language.....	80
[System] > [Maintenance] > [General]	81
Device Information	81
Tool	81
Initialization	81
[System] > [Maintenance] > [Backup/Restore]	83
Backup/Restore	83
[System] > [Maintenance] > [Update Firmware]	84
Device Information	84
Update Firmware	84
[System] > [Maintenance] > [Log]	85
View Logs.....	85

Chapter 4

Appendix

Troubleshooting	87
List of Log Messages	89
Log Messages on the Camera.....	89
Error Log	89
Warning Log.....	91
Notification Log	92
Restoring to the Factory Default Settings	96
Restoring to the Initial Settings from a Web Browser.....	96
Restoring to the Factory Default Settings with the RESET Switch on the Camera.....	96

List of Factory Default Settings	97
Specifications	100
CR-X300 Main Unit.....	100
Operating Environment	103
Appearance.....	104
Security Measures	106
Basic Measure 1: Setting Administrator Name and Password	107
Basic Measure 2: Using the Latest Firmware	107
Basic Measure 3: Setting Date and Time	107
Basic Measure 4: Monitoring the Log	107
Measures Suitable to the Users' Environment 1: User Management	108
Measures Suitable to the Users' Environment 2: Host Access Restrictions	108
Measures Suitable to the Users' Environment 3: Setting to the Digest Authentication.....	108
Measures Suitable to the Users' Environment 4: Changing the Port Number	109
Measures Suitable to the Users' Environment 5: Encrypting Communication.....	109
Measures Suitable to the Users' Environment 6: Disabling Unused Functions.....	109
Precautions When Disposing the Camera	110
Encrypting Backup Information	110
Index.....	111

Introduction

Thank you for purchasing a Canon Remote Camera (hereafter referred to as the camera).

This "User Manual" explains the camera installation, settings and operations. Read this document carefully before using the camera to ensure correct use. In addition, please be sure to read the next section, "Safety Precautions and Handling Instructions (Disclaimer)".

For the latest information on this product (firmware and software, user manuals, operating environment, etc.), refer to the Canon website.

Safety Precautions and Handling Instructions (Disclaimer)

Be sure to read these instructions in order to operate the product safely. Follow these instructions to prevent injury or harm to the operator of the product or others.

 Warning	Failure to follow the instructions may result in death or serious injury.
--	---

Installation

Request a professional installer for all installation work.

Never try to install the product yourself. Doing so may result in unforeseen accidents such as dropping the camera or electric shock. For installation or inspection of this camera, consult the dealer where you purchased the product.

Wiring work such as power supply and network should be carried out safely and securely in accordance with the relevant regulations.

Do not install the product in a location where there is the risk of ignition or combustion.

Installing the product in a location where flammable gases are produced or concentrated may cause ignition and result in fire.

Do not install the product in unstable places, places subject to significant vibration or impact, or places subject to salt damage or corrosive gas.

When installing the product in an elevated location, make sure to take appropriate measures in advance to prevent the equipment and parts from falling off.

Be sure to attach a safety wire when installing in a high place.

Depending on the installation location, install in such a way that sufficient holding strength can be secured.

Make sure that the mounting location and brackets and screws used for the mounting are capable of withstanding the total weight.

Failure to do so may result in the product falling or other accidents.

Do not install the product in locations subject to high temperatures, such as places exposed to excessive heat, near heat-generating objects, or in confined or enclosed places.

When installed outdoors, attach the included connector cover and protect the connection of the cover and a commercially available wiring hose using a commercially available cable protecting cover to prevent the intrusion of rain, etc.

When thunder starts to sound, stop installation or inspection, etc., and do not touch the camera, connection cable, etc.

Failure to follow the instructions may result in fire or electric shock.

Do not use the product for medical devices or other life-support systems.

Canon will assume no liability for any accident or damage resulting from use of the product under the conditions above.

Power Supply

Connect the power cable securely by inserting the plug fully into the camera correctly on one end, and properly wiring the other end.

Failure to follow the instructions may result in fire or electric shock.

Do not connect or disconnect the power cable or plug with wet hands.

Failure to do so may result in electric shock.

Do not leave the product plugged in for extended periods of time in locations exposed to high levels of dust, moisture or oily smoke.

Doing so may cause insulation failures and even fires.

Periodically wipe the terminal of the power cable and power outlet with a dry cloth to remove dust buildup.

Failure to follow the instructions may result in fire.

When using the DC IN 12V terminal, use the included power cable.

Using an unsuitable power cable may cause electric shock and fire.

When using a commercially available AC adaptor, use one that complies with the safety standards.

Using an unsuitable AC adapter may cause electric shock and/or fire.

If DC power is not used, do not connect the power cable.

Turn off the power when the camera is not used for a long period of time.

Failure to follow the instructions may result in fire or electric shock.

Handling

If any defective conditions such as smoke, strange sounds, heat, strange odors, damage or cracks on the external case are discovered, immediately stop using the product, disconnect from the power supply, and contact your nearest dealer.

Do not use flammable sprays near the product.

Do not allow liquids or foreign matter inside the unit.

Failure to follow the instructions may result in fire or electric shock.

Do not expose the product to strong shocks or vibration.

Failure to do so may result in the product falling or other accidents.

Do not scratch, pull, or forcefully bend the cables, or put a load on their connections.

Failure to follow the instructions may damage the cable, cause electrical leakage, and result in fire or electric shock.

Maintenance and Inspection

Stop the power supply before cleaning it.

Cleaning the product with a wet cloth with the power being supplied may result in electric shock.

Do not use organic solvents such as alcohol, benzene or paint thinner to clean the product.

Failure to follow the instructions may result in fire.

Do not disassemble or modify the product.

Failure to follow the instructions may result in fire or electric shock.

Inspect mountings regularly (every six months to one year) to ensure that screws are not rusted or they are securely tightened.

Failure to do so may result in the product falling or other accidents.

 Caution	Failure to observe the following precautions may result in injury or property damage.
--	---

Installation

Take care not to damage wiring or piping.

Failure to do so may result in damage to peripheral items.

Handling

Make sure that there are no people within the operating range of pan-tilt head section and camera housing section.

Do not touch the pan-tilt head section and the camera housing section during initialization.

The product hitting a person may cause injury.

Do not touch the edges of metal parts with bare hands.

Failure to do so may result in injuries.

■ Handling Precautions

- Do not hold the camera housing section. Failure to follow the instructions may result in damage.
- Take measures to remove static electricity before performing any procedures.
- Do not connect a PoE cable to the RS-422 terminal.
- Confirm that the video can be captured correctly, before using the camera, when the power is turned on for the first time after installation, or after not being turned on for a long time.
- After turning off the power, do not turn the power on again for at least five seconds.

- Do not point the camera at strong light sources (such as the sun on a clear day or strong artificial light sources). Internal components such as the image sensor could be damaged.
- Do not use or store the product outside the operating or storage environment. Failure to do so may result in damage due to the degradation of image quality or internal components.
- This product complies with the Dust-resistant/Waterproof Specification (IP65) rating. However, long exposure to rain may result in the corrosion of the outer shell, due to acid and heavy metals in the rain water.
- If there is condensation, wait to power on, until the condensation dissipates.
- Beware of freezing conditions. The product does not have a freeze-proof structure so take precautions when installing it in locations that may freeze. The product may not operate correctly if frozen.
- If the camera is installed outdoors, rain, snow, frost, etc. may adhere to the lens protector on the front of the camera, and visibility of the acquired video can be impaired. In addition, the lens protector may become dirty and the image quality may deteriorate due to the effect of dust or automobile exhaust fumes in the air. When installing the product outdoors, pay close attention to the impact of the surroundings on the video.
- Move the pan-tilt head regularly. Dust, water, snow, etc. may accumulate and cause image degradation or malfunction. In addition, to prevent dust from sticking to the lens, it is recommended that the pan-tilt head be tilted down with the enhanced ND filter activated when not in use for a long period of time.
- Pan and tilt may not operate properly in locations where strong winds may blow at 15 m/s or more.
- Do not use for vehicle-mounted operations. Vibration may cause loss of image quality or damage to internal components.



Important

- To prevent lightning damage, it is recommended to use a lightning rod or arrester (surge protective device or lightning protection transformer).

Disclaimer

- Canon shall bear no responsibility for damage resulting from improper operation of this product by the customer.
- Regarding this product's quality, functionality or instruction manual, Canon shall make no guarantees about its marketability or suitability for the customer's purpose. Moreover, Canon shall not be liable for any damage, direct or incidental, that results from using the product for the customer's purpose.
- Canon shall bear no responsibility for any loss, damage, direct or indirect, or any incidental loss, damage (including filming expenses and loss of filming earnings) arising out of the failure of this product or arising out of the use of this product.
- The product specifications, configuration, and appearance are subject to change without prior notice.
- For further information on repairs, maintenance, or adjustments not mentioned in this instruction manual, contact a Canon sales representative.
- Note that Canon may be unable to undertake servicing or repair of a product if it is modified without consulting Canon or your Canon sales representative.

Compliance with Applicable Laws/intellectual Property Rights: Please note that your use of this product may subject you to certain laws, rules and regulations, including but not limited to, privacy, wiretapping and intellectual property and publicity laws. Please be sure your use of this product and/or any resulting recordings or footage complies with applicable laws, rules and regulations.

Canon Inc. and its affiliates shall have absolutely no liability with respect to any claims made by third parties that your use of this product does not comply with applicable laws, rules and regulations and any resulting claims brought against you by third parties alleging non-compliance with such laws, or otherwise violates any third party's intellectual property, personal, privacy or proprietary rights as a result of your use of the product. We are also not responsible to you for any liability whatsoever resulting from your use, and/or installation of this product, and/or any loss of any recordings or footage.

Limited Warranty: Please check the in-box materials for more information about the limited warranty that pertains to your product.

Installation: This product should NOT be installed outdoors. You are solely responsible for the proper installation of this product. **To the extent permitted by law, Canon Inc. and its affiliates shall have absolutely no liability to you with respect to any damages or liabilities associated with the improper use of, or the installation of this product, or for any personal injuries sustained by you or any third parties as a result of any such improper**

use or installation of this product, whether or not the installation of this product was by you, or by any third party.

Privacy:

- Do not install this product in areas where people have a reasonable expectation of privacy, including but not limited to, bedrooms, dressing rooms, locker rooms and rest room facilities.
- Some jurisdictions require signage disclosing the existence of camera equipment. Please check your own area's laws for requirements.
- Making audio recordings is heavily regulated and can vary significantly by area. Please check laws in your jurisdiction before making any audio recordings.

OTHER IMPORTANT INFORMATION: Please see other important information pertaining to the use of this product by reading our User Manual, which can also be found at global.canon/ncsp, prior to using this product.

Trademarks

- Microsoft, Windows and Microsoft Edge are trademarks or registered trademarks of Microsoft Corporation in the United States and other countries.
- Windows is legally recognized as the Microsoft Windows Operating System.
- macOS is a trademark of Apple Inc., registered in the United States and other countries.
- Safari is a trademark of Apple Inc.
- IOS is a trademark or registered trademark of Cisco in the U.S. and other countries and is used under license.
- HDMI is a trademark or registered trademark of HDMI Licensing Administrator, Inc. in the United States and other countries.
- NDI is a trademark or registered trademark of NewTek, Inc. in the United States and other countries.
- All other company or product names used in this document are trademarks or registered trademarks of their respective holders.

Software License Agreement

For the software license agreement, refer to the text file provided with the software and installer.

Except as expressly permitted by the law in effect in the jurisdiction in which you are located, you shall not reverse engineer the firmware which is contained in this product ("Firmware") and you shall not modify the Firmware. TO THE FULL EXTENT PERMITTED BY APPLICABLE LAW, IN NO EVENT SHALL EITHER CANON, OR CANON'S LICENSORS BE LIABLE FOR ANY DAMAGES WHATSOEVER ARISING OUT OF USING THE FIRMWARE. The Firmware may contain third party software components. Notwithstanding anything contained herein to the contrary, the terms and conditions of such third party software components shall be applied to your usage of the Firmware.

Third Party Software

This camera contains third party software modules. Confirm each module's license conditions in [System] > [Maintenance] > [General] > [Tool] > [See Third Party Software License Conditions] on the Settings Page.

Software Licensed Under the GPL and LGPL

If you would like to acquire the source code licensed under the GPL and LGPL, please contact us using one of the following methods:

- (1) To receive an e-mail with the URL to download the source code, access <https://global.canon/en/oss/scd/index.html> and complete the request form; or
- (2) To receive the source code by post, send us a letter in writing to the address below with the following information.
In the case you have chosen (2), WE MAY CHARGE YOU for the delivery cost.
 - (i) Your Address (Country/Region, ZIP code, Address, Your name) [mandatory]
 - (ii) Your e-mail address (for the purpose of possible communication with us) [optional]
 - (iii) Product Name/Application Name [mandatory]

(iv) Product/Application Software Version [optional]

If you do not specify a version, we will send source code corresponding to the latest version.

– Address:

Open Source Promotion Division, Canon Inc.

30-2, Shimomaruko 3-chome, Ohta-ku, Tokyo 146-8501, Japan

– For Canon's privacy policy, refer to Canon Global Website <<https://global.canon/>>.

This product is licensed under AT&T patents for the MPEG-4 standard and may be used for encoding MPEG-4 compliant video and/or decoding MPEG-4 compliant video that was encoded only (1) for a personal and non-commercial purpose or (2) by a video provider licensed under the AT&T patents to provide MPEG-4 compliant video. No license is granted or implied for any other use for MPEG-4 standard.

THIS PRODUCT IS LICENSED UNDER THE AVC PATENT PORTFOLIO LICENSE FOR THE PERSONAL USE OF A CONSUMER OR OTHER USES IN WHICH IT DOES NOT RECEIVE REMUNERATION TO (i) ENCODE VIDEO IN COMPLIANCE WITH THE AVC STANDARD ("AVC VIDEO") AND/OR (ii) DECODE AVC VIDEO THAT WAS ENCODED BY A CONSUMER ENGAGED IN A PERSONAL ACTIVITY AND/OR WAS OBTAINED FROM A VIDEO PROVIDER LICENSED TO PROVIDE AVC VIDEO. NO LICENSE IS GRANTED OR SHALL BE IMPLIED FOR ANY OTHER USE. ADDITIONAL INFORMATION MAY BE OBTAINED FROM MPEG LA, L.L.C. SEE [HTTP://WWW.MPEGLA.COM](http://www.mpegla.com)

This product comes with exFAT, a licensed file system technology from Microsoft.

Types of User Manuals

The following describes the different types of user manuals. When instructed to reference another manual, its name will be listed as shown below.

Important Information (included)

Explanation on safety precautions and downloading information from the Canon website.

User Manual (this document)

Explanation on procedures for installing and connecting the camera, settings on the Settings Page, troubleshooting, and major specifications.

Remote Camera Control Application User Manual

Explanation on the details on how to use the Remote Camera Control Application.

Remote Camera Controller RC-IP100 User Manual

Explanation on the details on how to use the Remote Camera Controller RC-IP100.

How to Use This Document

The assumed reading format of this document is on a computer screen.

■ Notes



- 1 Any unauthorized reproduction of this document is prohibited.
- 2 The contents of this document are subject to change without any prior notice.
- 3 This document has been prepared with the utmost attention to accuracy. If you have any comments, however, please contact a Canon sales representative.
- 4 Canon shall assume no liability for any outcome of using this product, notwithstanding items 2 and 3 above.

■ Software Screenshots

The software screenshots samples shown in this document are for illustration only. The screenshots may differ from the actual screens displayed.

Descriptions use sample screens when connected to the camera, with Windows 10 for the operating system and Google Chrome for the web browser.

■ Symbols Used in This Document

Symbol	Meaning
 Important	Cautions and restrictions. Make sure to read these carefully.
 Notes	Supplementary descriptions and reference information.

Names of Parts

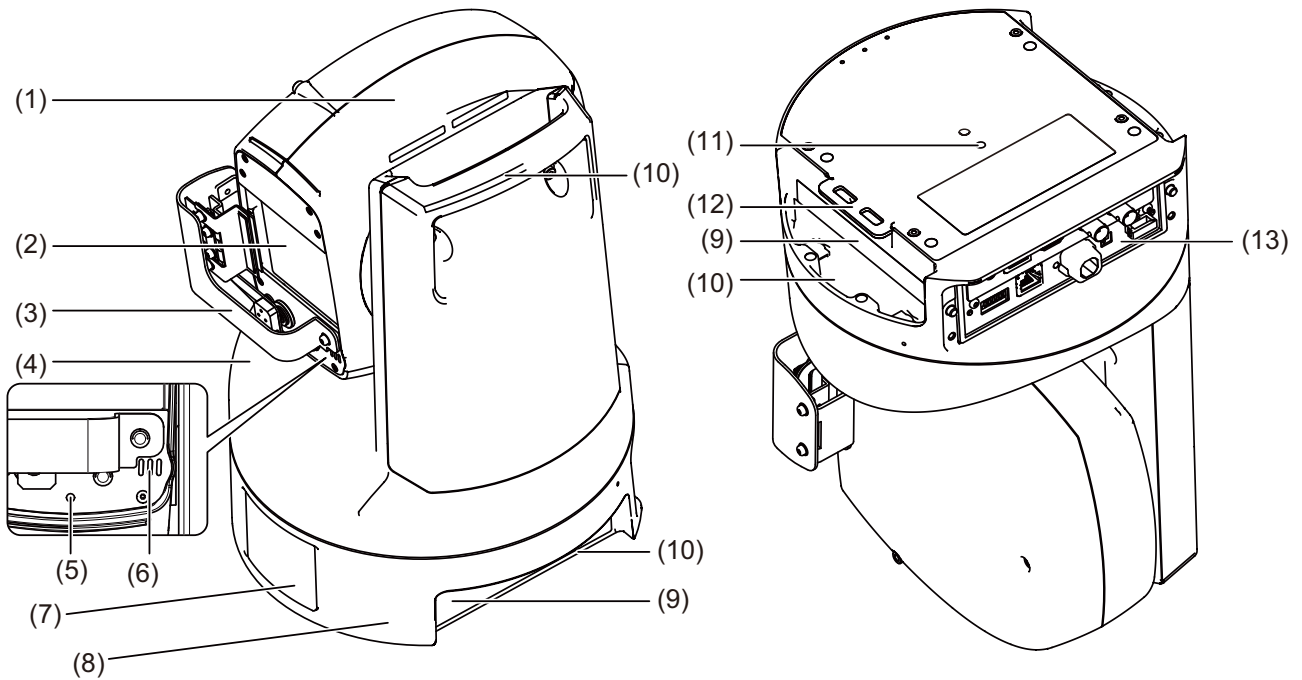

(1) Camera housing

(2) Lens protector

(3) Wiper

(4) Pan-tilt head

(5) Tally lamp

Red light is on during streaming. Lights are off when preparing for streaming (P. 31) or not streaming.

(6) Microphone

(7) Logo plate

(8) Base

(9) Rating label (x2)

(10) Handle (x3)

Refer to "Carrying the Product" (P. 20).

(11) Screw hole for tripod

(12) Through hole for safety wire

(13) Receptacle unit

Receptacle Unit

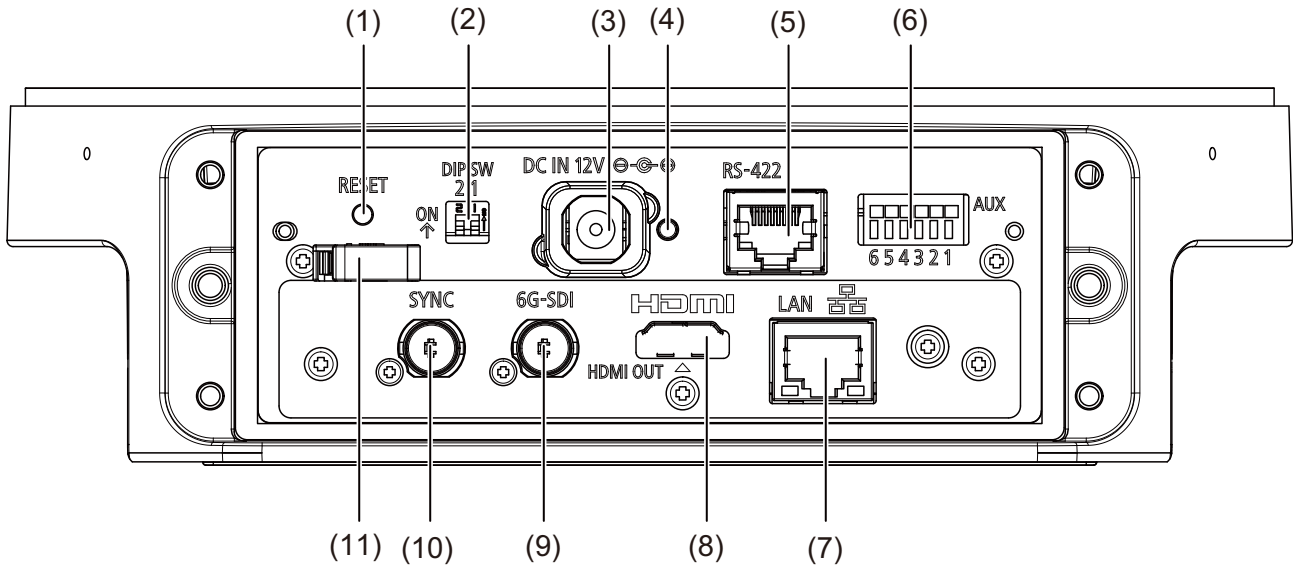

(1) RESET switch

Reset the camera settings to factory defaults.
For details, refer to "Restoring to the Factory Default Settings" (P. 96).

(2) DIP SW (switch)

These switches are for future expansion.

(3) DC IN 12V terminal

Input terminal of the DC power supply. Use the included power cable to connect to the power supply. The black line with white indication line is +, and just the black line is -. Connect to the power supply that meets the installation site requirements (approved products and the environment) and product specifications. In addition, note that inrush current may cause the power supply to be insufficient and cause failure when power is turned on. Therefore, it is recommended to use a power supply with a power capacity of two to three times the rated capacity or more. For the power supply, refer to "Others" (P. 102).

Important

- Use the included power cable when using the DC power supply or AC adapter.
- The terminal has a block part to prevent incorrect insertion. Ensure the power cable is fully inserted into the terminal, and the POWER lamp blinks (green).
- The incorrect insertion prevention block part is designed to have a little room for play so that it can move. This is not a defect.

(4) POWER lamp

Lamp status	Status
Green light ON	Power ON
Green light BLINKING	Starting/Rebooting Changing to or from standby
Orange light ON	Standby Insufficient power
Orange light BLINKING	Pan/Tilt position error Firmware being updated Device failure/Error

(5) **RS-422 Terminal**

Serial terminal (RJ-45 connector) supporting for RS-422.
Connect GND to each other to stabilize the voltage level of the signal.
Use category 5e or higher STP cables.

Pin number	Function	
1	TX-	Output (-)
2	TX+	Output (+)
3	RX-	Input (-)
4	GND	-
5	GND	-
6	RX+	Input (+)
7	NC	-
8	NC	-

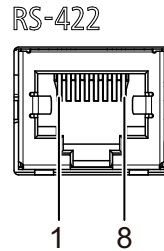

(6) **AUX (auxiliary) terminal**

Control terminal for external devices. Usable wire is AWG 28 to AWG 22, stripping wire length 9 to 10 mm.
When connecting with other device outdoors, use cables up to 3 m in length.

Number	Signal
1	ACC. CONT (open drain)
2	+12 V output (350 mA or less)
3	AUX OUT (3)
4	AUX OUT (4)
5	GND
6	AUX IN

Terminal for washer

To connect to a washer (commercially available), use ACC.CONT (open drain) and + 12 V output (350 mA or less) terminal.

Output terminal for external device

The external device output terminals consist of one set of two terminals (AUX OUT (3), AUX OUT (4)). There is no distinction between + and - for terminals. By controlling the internal controller, the conduction state and the insulation state between the two terminals can be switched. An optical coupling element is used for the output terminal, and it is separated from the internal circuit of the main unit.

Keep the connection load within the following ratings for the output terminal.

Rating between output terminals: DC maximum voltage 50 V

Continuous load current 200 mA

Input terminal for external device

The input terminal for external device consists of one set of two terminals (AUX IN and GND), and the GND terminal is connected to GND inside the main unit.

An interrupt is generated to the internal controller by connecting a cable to the AUX IN and GND terminals and electrically connecting (ON) or insulating them (OFF).

Connect the sensor or switch to a terminal that is electrically isolated from the power supply or GND.

Internal connection diagram

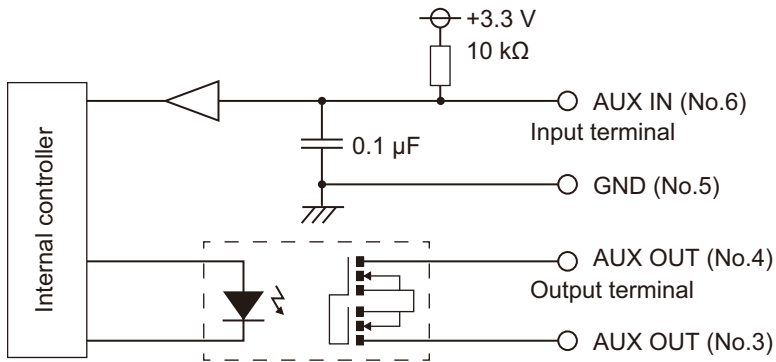

(7) LAN terminal

Terminal (RJ-45 connector) for network connections.

With PoE++ (Power over Ethernet++) capability, it is possible to provide power to the camera from the PoE++ supported hub which compile IEEE802.3bt Type 2 through a LAN cable.

Use an STP (shielded) type LAN cable with a length of 100 m or less and with a category 5e or more. Use a category 5 or less cable may reduce the power supply capacity.

Important

- Some PoE++ supported hubs can limit power usage on each port, however doing so may cause failure to operate correctly. In this case, do not limit power usage on any port.
- Other PoE++ supported hubs can limit the total power consumption of each port, however using multiple ports doing so may fail to operate correctly. Refer to the instruction manual of the PoE++ supported hub for use.

(8) HDMI OUT terminal

Terminal for HDMI output. Take necessary measures to prevent the cable from coming off, such as using a commercially available cable retaining part.

(9) 6G-SDI terminal

Output terminal (BNC connector) for uncompressed digital video and digital audio.

(10) SYNC terminal

Input terminal (BNC connector) for the external synchronization signal.

(11) Cable clamp

A cable clamp to prevent the power cable from coming off. Thread the cable to prevent it from coming off.

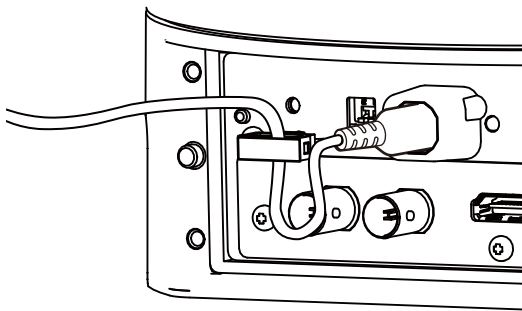

Note

- The camera does not have a power switch. Turn on/off the power by connecting/disconnecting the power cable or LAN cable or using the switch of the device that supplies power.
- If power is supplied from both DC power and PoE++, power from DC power has a priority. If the power supply is stopped from DC power while power is supplied from both DC power and PoE++, power supply to the camera will be stopped. In this case, disconnect the LAN cable to stop power supply from PoE++, reconnect the cable and restart, and power will be supplied again.

Related Software

The following software can be used to set up and operate the camera efficiently. Download the software to use from the website written in the "Important Information".

Camera Search Tool

This tool is used for connecting the camera to the computer over a network first.
For details, refer to "Initial Camera Settings" (P. 26).

Remote Camera Control Application

This software is used for operating cameras while checking the camera videos. This software can perform the following operations on the camera.

- Pan, Tilt, Zoom operation
- Preset movement
- Trace function

For details on uses and functions, refer to "Remote Camera Control Application User Manual".

Examples of System Configuration

System Layout

This camera can be used by connecting with the following devices.

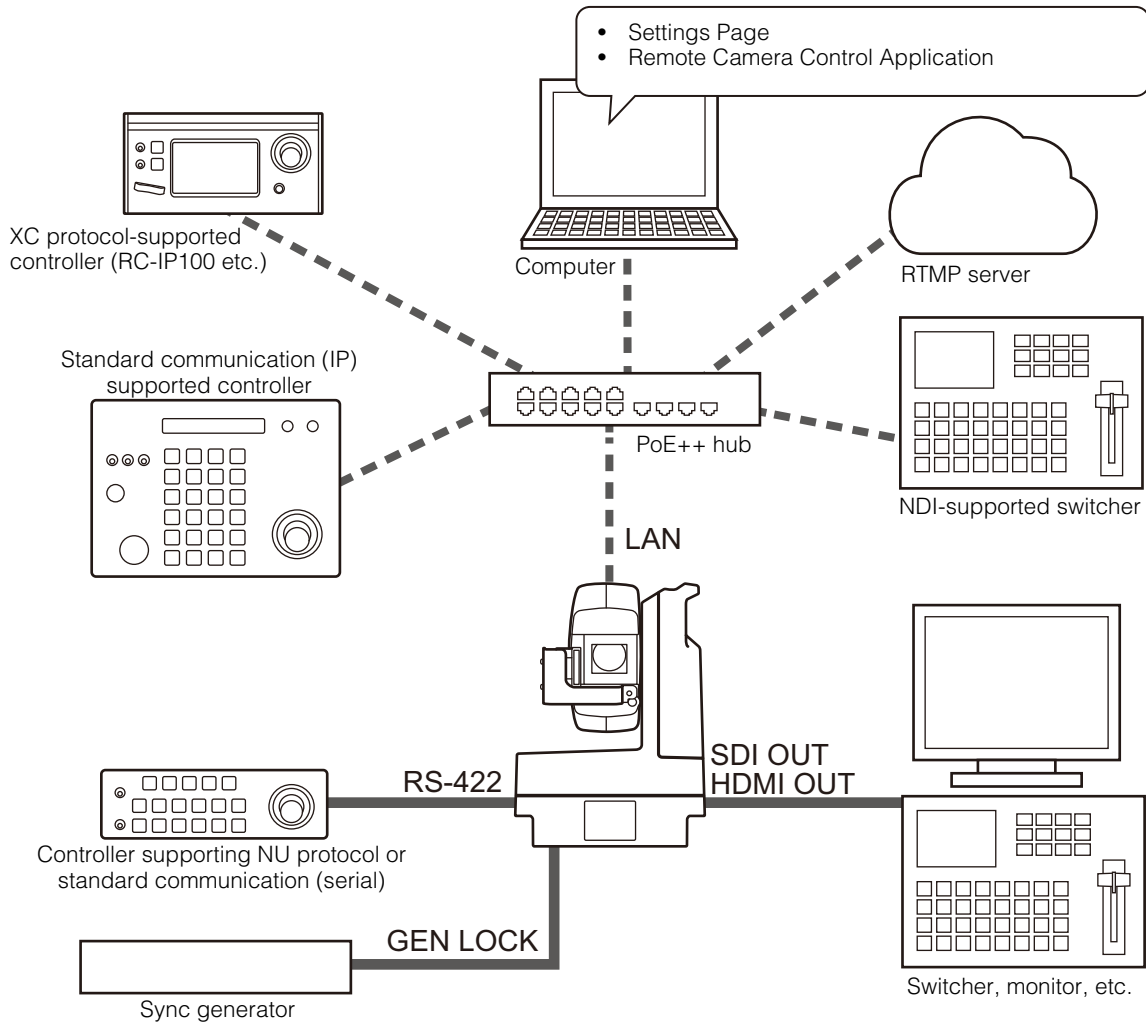

System Layout Example 1

The following is an example of a connection in which a network connected controller controls a camera and outputs SDI.

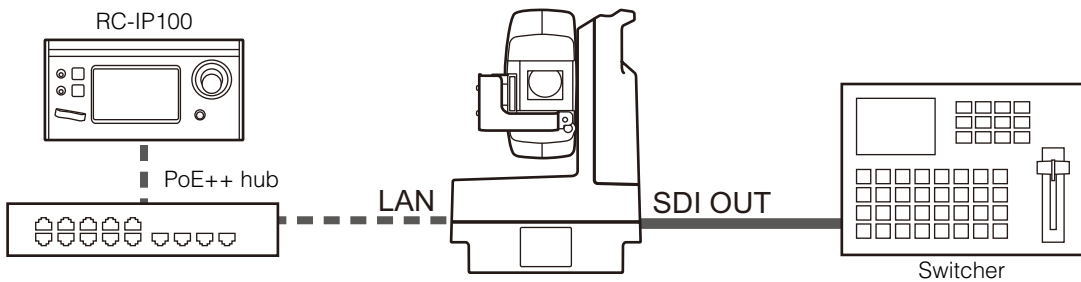

■ System Layout Example 2

The following is an example of network connected camera control using application.

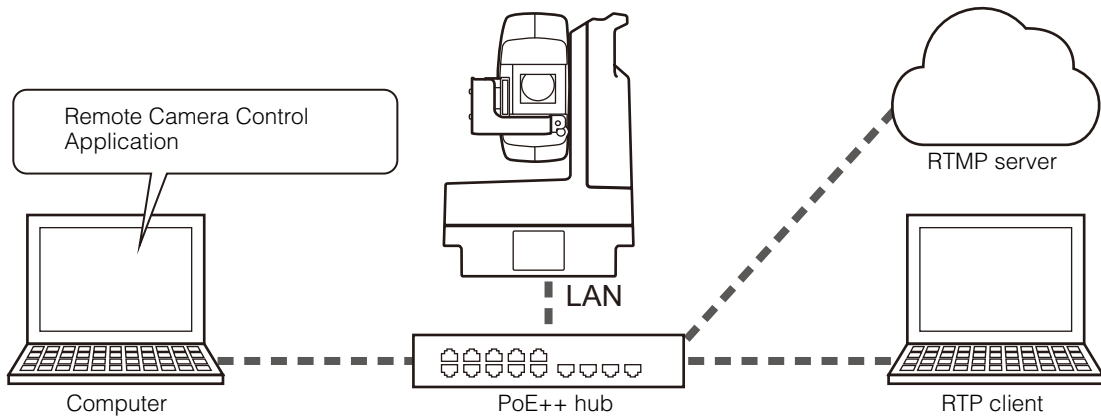

■ System Layout Example 3

The following is an example with no network connection. Even if network communication is not used during shooting, it is necessary to connect to the network beforehand and perform the initial settings from the computer.

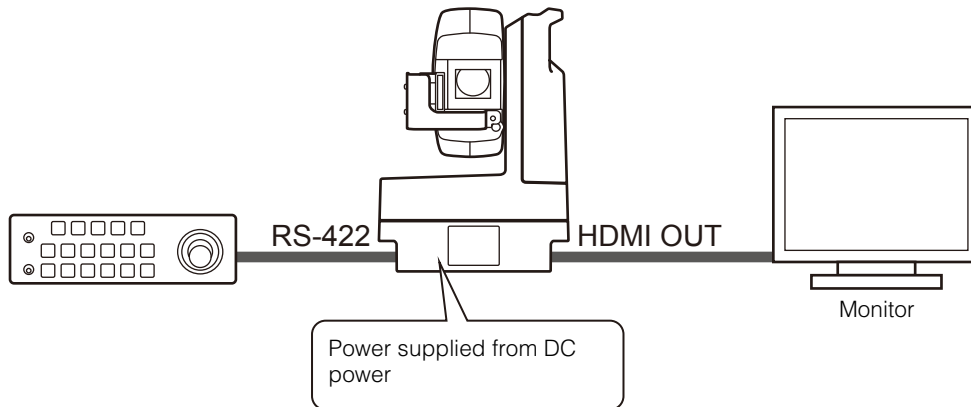

Chapter 1

Installation and Connection

This chapter explains the procedure for installing and connecting the camera and daily maintenance.

Installation

Carrying the Product

When carrying the product, hold the upper handle (1) or hold the two lower handles (2) simultaneously.

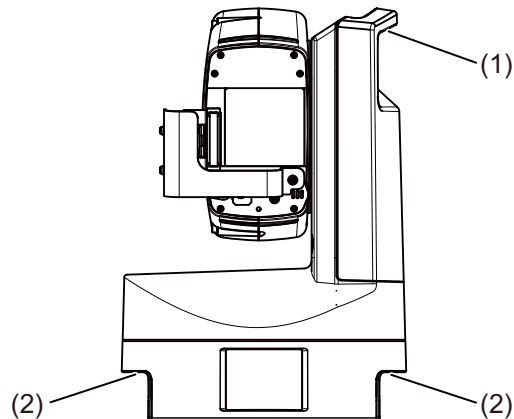

Mounting the Head Unit

Prepare a bracket matching the dimensions of the four M6 taps on the bottom surface.

Use steel screws with a bolt length equivalent to the bracket thickness + 15 to 20 mm, and fix it by tightening torque of 2 to 4.9 N · m (20 to 50 kg · cm).

Use a level to check that the base is horizontal.

■ Installation in a High Place

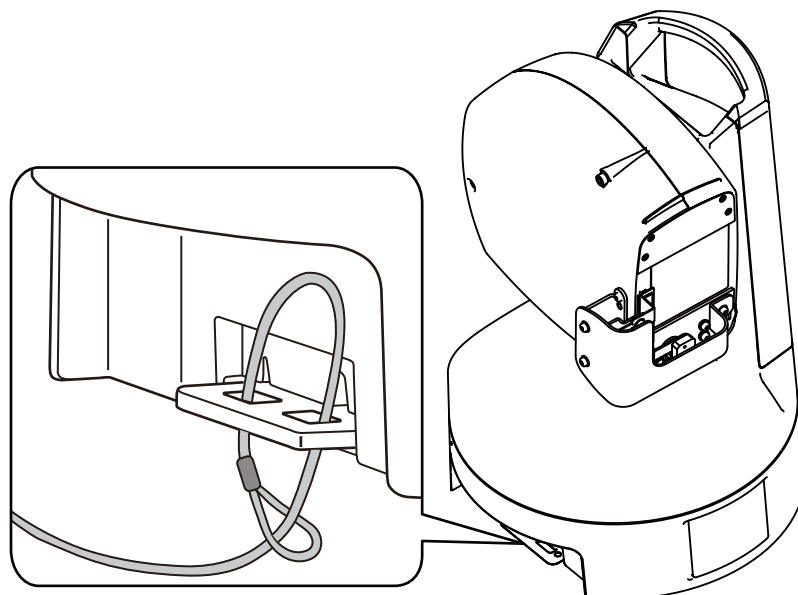

When there is a risk of falling, such as installation in a high place or mounting on the ceiling, be sure to insert a commercially available safety wire that can withstand the total weight including the camera and mounting bracket through the two through-holes and secure the wire to a sturdy structure.

■ Ceiling Mount

Do not use the screw holes for tripod but use the mounting bracket to install the camera.

When installing the product outdoors using a pole, etc., to prevent rain and bird damage, prepare mounting brackets of $\varnothing 290 \pm 5$ mm (mounting brackets of larger than $\varnothing 300$ mm will be captured) matching the dimensions of the four M6 taps on the bottom surface.

The logo plate can be turned upside-down. Pull up gently the right and left sides of the logo plate to pull it out, rotate it and push it back into place.

Using a Tripod

Attach the tripod by fixing a screw to the screw hole for tripod.

Use 1/4-20UNC screws and tighten them securely, and set the tripod on a flat surface with no steps.

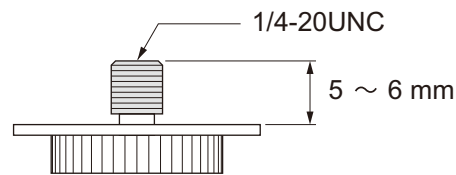

Attaching the Connector Cover

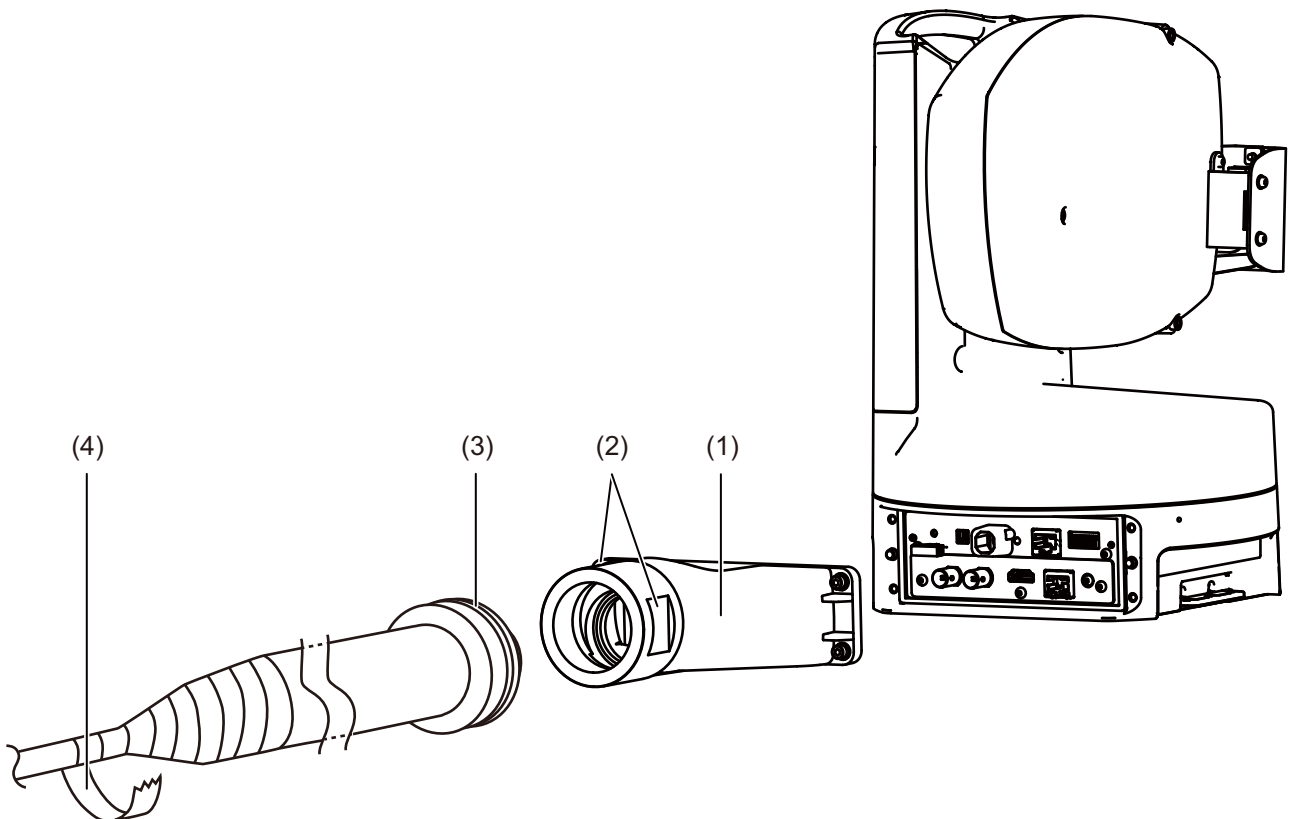

■ Preparation before Attaching

- Thread each cable through the connector cover (1).
- Connect each cable to each connector on the receptacle unit. Make sure that the cables are securely attached so that they will not come off. Use a cable clamp for the power cable (P. 15). For HDMI cable, if necessary, use a cable retaining part to take measures to prevent it from disconnecting.
- If not using an IP connection, configure the control protocol.
- Take necessary measures against lightning damage.

■ Attaching

- Connector cover
Attach the connector cover to the receptacle unit and affix it securely with four screws.
- Protecting cover
Prepare a commercially available cable protecting cover (3) which opening fits the M50 (screw length is 20 mm or shorter).
In mounting the protecting cover, hold two cuts on both sides of the cover (2) to avoid giving stress to the resin part of the cover.
Put the self-welding tape (4) firmly around the end of the protecting cover so that there is no space between the cable and the cable hose.

Protecting cover (recommended)

Made of metal

Manufacturer: SANKEI

Model: KMBM 42 (Connector for knockout)

KUU 42 (Hose, KEIFLEX)

Made of resin

Manufacturer: Flexa

Model: RQG48-M50 (RohrFlex connector)

FS-M 50 (Gasket for RohrFlex)

Routine Maintenance

Confirmation of Video Image

Regularly check to make sure the set capture area is not misaligned, and is still in focus.
If necessary, re-adjust the product.

Cleaning Method

Before beginning any work, turn off the power.

■ Cleaning the External Cover and Lens Protector

- 1** Wash off foreign substances such as dust and sand using clean water.

If the connector cover is not attached, wipe with a soft cloth dampened with clean water as it cannot be washed away directly with water.

- 2** If the lens protector is dirty with something that cannot be removed with water, such as fingerprints or oil, gently wipe the lens protector clean with a soft sponge or cloth dampened with a neutral dishwashing detergent diluted to approximately 1% with water.

- 3** Wipe them clean with a soft cloth that has been dampened with clean water to ensure that water droplets and detergent do not remain.



Important

By performing an incorrect cleaning method, the external cover or lens protector could become scratched and will need to be replaced for a fee. Therefore, follow the next set of instructions carefully.

- Because of dust, dirt, or fingerprints etc., the auto focus may not work properly or the reflection of backlight or infrared light may cause the image to become white and cloudy. In order to preserve the level of image quality, regular cleaning is necessary.
- Do not wipe with a dry cloth. Never wipe with a cloth especially without removing the attached grime. This may result in scratches to the external cover or lens protector.

Chapter 2

Default Settings

It describes the preparation and settings after installing the camera.

Security Checking/Settings

The security function of the OS or web browser may block the settings and operation of the camera. Check the security settings beforehand, and change the settings if required.

Checking the Firewall Settings (Windows)

To use the software on a computer with Windows Defender Firewall enabled, it is necessary to add each piece of software as an application that allows communication through the firewall.



Note

If applications were not added in this procedure, they can still be added as allowed applications in the [Windows Security Alert] dialog that appears when starting the software.

- 1** Click [Windows Defender Firewall] in [Control Panel] > [Systems and Security].
- 2** Click [Allow an app or feature through Windows Defender Firewall].
- 3** Click [Change Settings] > [Allow another app].
- 4** Select [CameraSearchTool.exe] downloaded from the website, and click [Add].

Initial Camera Settings

In order to use the camera, it is necessary to first connect the computer to the camera via network then set the Administrator Account.

Settings Using the Camera Search Tool

Here, by using the Camera Search Tool and accessing the camera's initial settings screen, the method to initialize the camera to the factory default settings is explained.

Camera detection by this tool is valid only for cameras in the same network.

- 1 Connect the camera to the computer on the same network, then turn on the power.
- 2 Double-click the CameraSearchTool icon downloaded from the website.



Windows: CameraSearchTool.exe
macOS: CameraSearchTool.app

When starting this tool, cameras on the same network are automatically detected and the acquired information is displayed in a list.

In the case the camera is not automatically detected, click [Search Camera].

Note

- Even if the network addresses of the computer and the camera are different, if IPv6 of the computer is enabled, the camera will be detected using the IPv6 link-local address.
- If IPv6 is not available, either assign an IPv4 address on the DHCP server or use the AutoIP feature to detect the camera. To use the AutoIP function, make the following settings, and connect the computer and camera to a network environment without a DHCP server. Each computer and camera will be assigned an IPv4 link-local address of 169.254.xxx.xxx and will belong to the same network, so the camera can be detected.

Windows: set the computer to [Automatically obtain IP address] in the Windows network settings.

macOS: [System Preferences] > [Network], then set [IPv4 Settings] to [Use DHCP server].

- 3 Click the IP address of the camera to be initialized.

Windows:

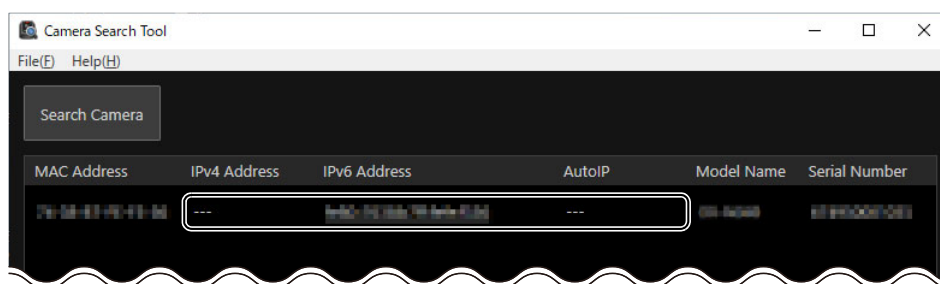

macOS:

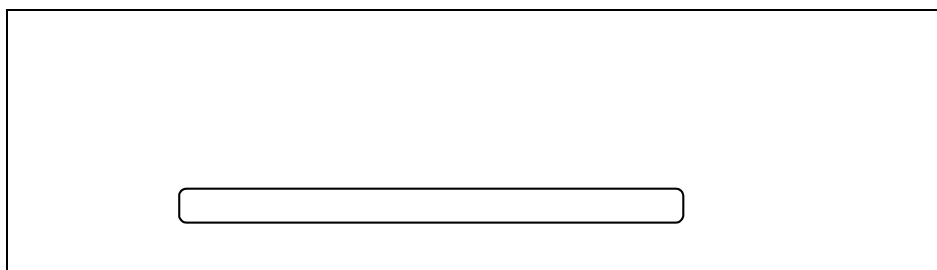

The web browser starts and the [Default Settings (1/2)] screen of the camera is displayed.

- 4 Enter the Administrator Name and Administrator Password, select [Language], and click [Apply and Reboot].

After rebooting the camera, the [Default Settings (2/2)] screen is displayed.



Important

To ensure system security, set the administrator password that should not be easily guessed by third parties. Be sure not to forget the password.

- 5 Set the [Frame Frequency (Hz)], [Network], and [Date and Time], then click [Apply] or [Apply and Reboot].

After the camera reboots, the Settings Page is displayed and settings are able to be configured.

If the [Network] settings are changed, the camera may be unable to be connected from the operating web browser. In this case, check the connection with computer according to the set network settings, and then reconnect.

For details on the settings, refer to "System Settings" (P. 52).



Note

The video size and frame rate options for the output video are determined according to the set frame frequency.

- 6 Repeat steps 3 to 5 to initialize multiple cameras.

To exit the Camera Search Tool, click [Exit] in the menu or click the  button on the screen.

Camera's Settings Page from the Web Browser

Able to access the camera by directly specifying the IP address from a web browser.

If there is an IP address assigned by the DHCP server, specify it, otherwise specify "192.168.100.1".

Important

- Able to access with the IP address of 192.168.100.1 approximately two minutes after connecting the camera to the network environment.
- If an IPv4 address is assigned by the DHCP server, it will switch to that address and access by 192.168.100.1 will not be possible.
- If there is device with 192.168.100.1 on the same network, the same IP address will be assigned, and access to the camera with 192.168.100.1 will not be possible.

1 When accessing with 192.168.100.1., set the IP address of the computer.

Set the IP address of the computer to the same network as 192.168.100.1 such as 192.168.100.xxx.

2 Launch the web browser.

3 Enter the camera's IP address in the address column of the web browser and press [Enter].

The [Default Settings (1/2)] screen of the camera is displayed.

4 Perform steps 4 to 5 of the previous section "Settings Using the Camera Search Tool".

After the camera reboots, the Settings Page is displayed and settings are able to be configured.

Note

If necessary, restore the computer settings changed in step 1.

Chapter 3

Camera Setup

The settings required to use the camera are made on the Settings Page. Before starting operation, make various settings on the Settings Page according to the shooting conditions and purpose. There are also menus that can be performed during operation, such as camera maintenance.

Overview

Follow the steps below to connect to cameras to display the Settings Page.

Accessing from a Web Browser

Enter the IP address set in "Initial Camera Settings" (P. 26) directly into the web browser to display the Camera's Settings Page.

The Settings Page can only be connected with an Administrator Account.

Important

- In the case the Administrator Account is forgotten, return settings to factory default settings (P. 96). However, because the Administrator Account and other settings will be initialized, it will no longer be able to connect to the camera as it is. Use the Camera Search Tool to configure the default settings.
- Do not open multiple Settings Pages at one time and try to change the settings of a single camera.

- 1** Launch the web browser.
- 2** Enter the IP address and press Enter.
The authentication screen of the Settings Page is displayed.
- 3** Enter Administrator Name and Administrator Password, then click [Sign in].

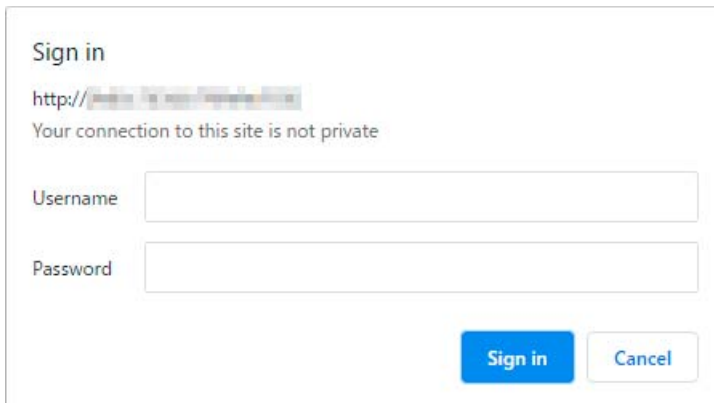

Sign in

http://
Your connection to this site is not private

Username

Password

The Settings Page is displayed.

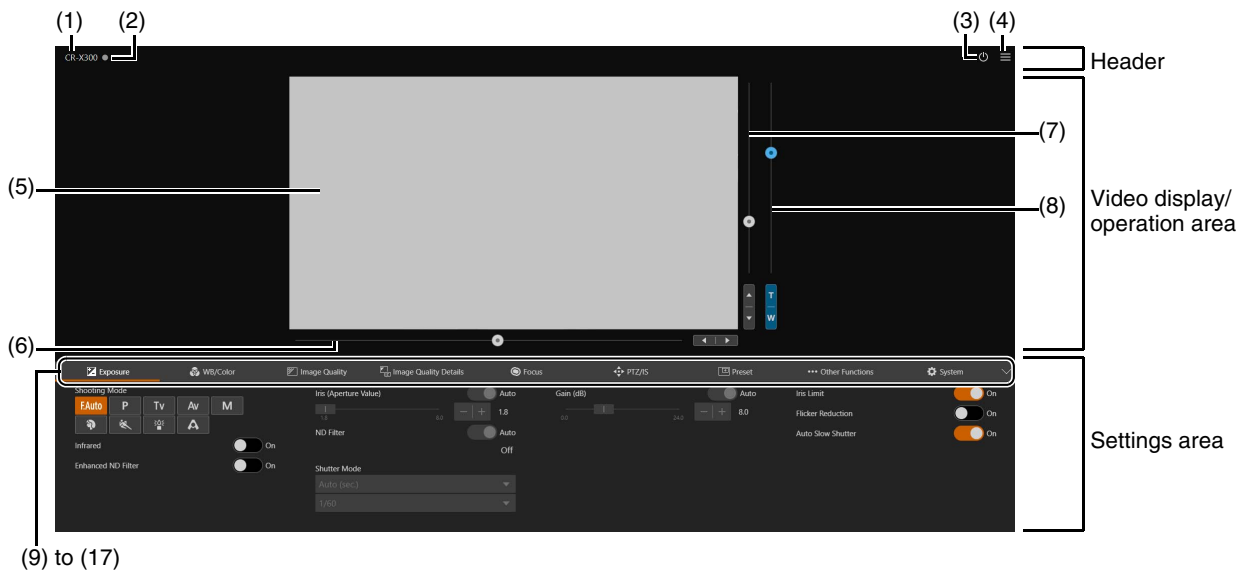

Configuration of the Settings Page

The configuration of the Settings Page is as follows:



■ Header

This area is common to all Settings Pages.

- (1) **Model Name**
Displays the model name of the connected camera.
- (2) **Tally Lamp Status Display**
Displays the video distribution status with the Tally Lamp.
 - : Distributing
 - : Preparing for distribution
 - : No distribution
- (3) **Power ON/Standby**
Switches between the camera on and standby mode. Set it to standby mode if needing to stop HDMI/SDI output or IP distribution of videos.
If  is clicked while the camera is on, "This will switch to standby. Do you want to continue?" message will appear. Click [OK] and "On Standby" will appear in the video display area and will go into standby mode. Click [Start Up] to return to the power on state.
The Status of the camera can be confirmed by the POWER lamp at the rear of the camera (P. 13).
- (4)  **Menu**
Click to display a list of items in the settings area.
For details of the items, refer to "Settings area" (P. 32).

■ Video display/operation area



Displays the video received from the camera. Also, operates the pan, tilt, and zoom of the camera.

(5) Video Display Area



JPEG video is displayed.

When the image cannot be displayed, the  Reconnect button appears in the center of the screen.

(6) Pan Slider (P. 33)

Move the camera angle left or right. Use the  or  button to fine-tune the position.

(7) Tilt Slider (P. 33)

Move the camera angle up or down. Use the  or  button to fine-tune the position.

(8) Zoom Slider (P. 33)

Move up to zoom in (telephoto) or down to zoom out (wide angle).

Use the T or W button to fine-tune the position.

■ Settings area

Change camera settings. Click each tab to switch the settings area.

(9) [Exposure] tab (P. 35)

Sets exposure settings.

(10) [WB/Color] tab (P. 40)

Setting the white balance and color matrix settings.

(11) [Image Quality] tab (P. 42)

Setting the image quality.

(12) [Image Quality Details] tab (P. 43)

Sets advanced image quality settings.

(13) [Focus] (P. 45)

Sets focus settings.

(14) [PTZ/IS] tab (P. 48)

Sets pan, tilt, and zoom operations and image stabilizer settings.

(15) [Preset] tab (P. 49)

Sets the preset settings.

(16) [Other Functions] tab (P. 51)

Sets various settings related to the camera control such as color bar or external device output.

(17) [System] tab (P. 52)







Configure advanced camera system settings such as video and audio, server, communications, and security.

If this tab is clicked, the video display/operation area disappears, and the screen will be configured with the setting item category and the settings screen.

Important

Do not use the [Back] and [Forward] buttons on the Web browser to navigate through the settings page. The changed settings may be reverted or unintended changes may be applied.

Note

- By clicking  at the right of the tab area, the Settings area will be hidden, and only the video display/operation area will be displayed.
It will be reverted by clicking .
- If the width of the screen is narrow, tabs can be switched by using the   buttons. Also, for each Settings area, it is possible to switch the display by using the   buttons at the bottom of the screen or by clicking .

Camera Operation

Set the camera angle by operating the camera's pan, tilt and zoom.

Note

Camera control by clicking and dragging does not guarantee exact precision.

Operation by Clicking on the Video Display Area or by Slider

Click Operation

When clicking on the video display area, the camera angle moves so that the position of the mouse pointer is at the center.

If a single click does not center the desired location, repeat the operation.

Note

When operating [Focus], the camera angle cannot be centered by clicking on the video display area.

Slider Operation

Dragging the pan and tilt slider knobs pans and tilts the camera.

Drag the zoom slider knob to operate the zoom.

The slider knob moves even if clicking the slider on the point without the knob.

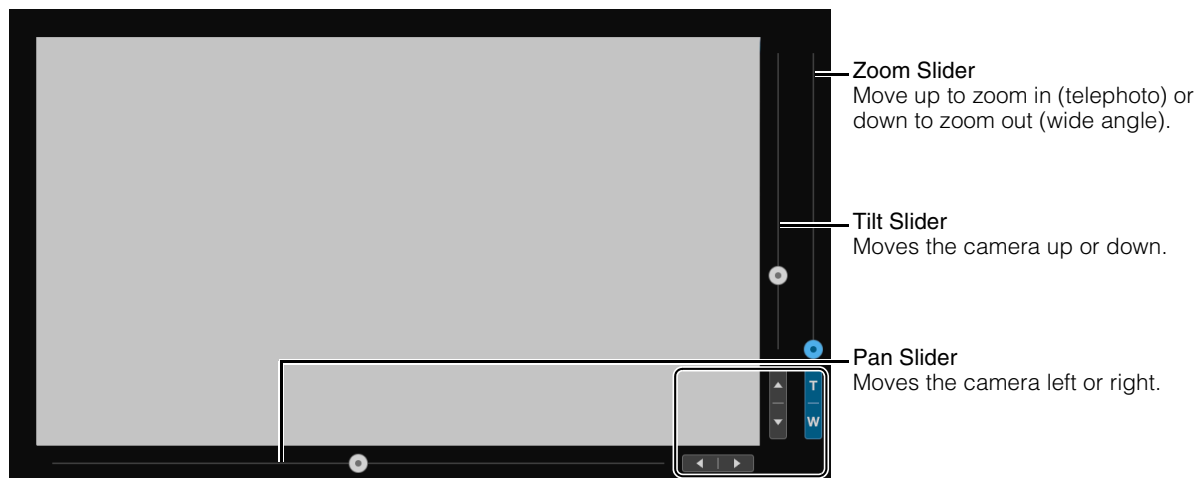

Fine tune the pan, tilt, and zoom positions by clicking the ◀ or ▶, ▲ or ▼, or T or W buttons.

■ Slider Operation When Using the Digital Zoom and Digital Tele-Converter

When [PTZ/IS] > [Digital Zoom] is set to [400x], the digital zoom area is displayed on the zoom slider and digital zoom operation is enabled.

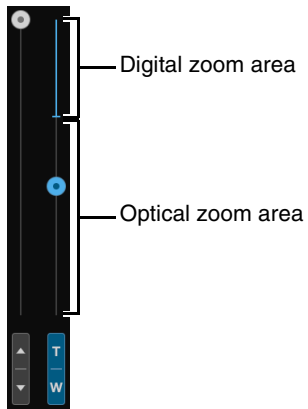

When [PTZ/IS] > [Digital Zoom] is set to [Digital Tele-Converter] (P. 48), the video is magnified according to the magnification selected, but the position of the slider does not change.

Exposure Settings

Settings for the shooting mode according to the shooting environment and subject, as well as the iris, shutter speed, and gain.

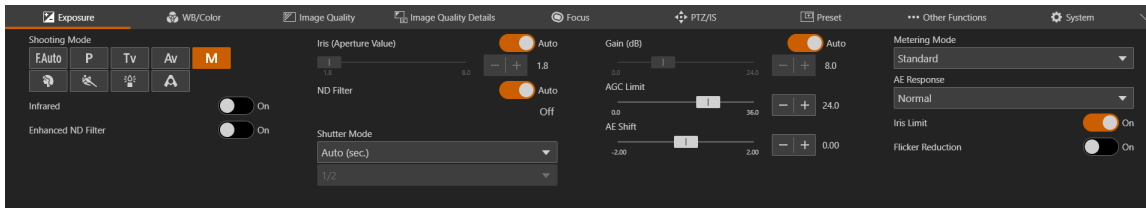

[Shooting Mode]

Switches the shooting mode according to the shooting environment and subject.

F.Auto (Full Auto)

The exposure (iris, shutter speed, gain, etc.) and white balance settings are adjusted automatically.

P (Program AE)

The exposure (iris, shutter speed, gain, etc.) settings are adjusted automatically. It is possible to set [AGC Limit], [AE Shift], [Metering Mode], and [AE Response].

Tv (Shutter Priority AE)

The shutter speed is adjusted manually. The gain and iris are adjusted automatically.

Av (Iris Priority AE)

The iris is adjusted manually. The shutter speed and gain are adjusted automatically.

M (Manual Exposure)

The exposure (iris, shutter speed, gain, etc.) is adjusted manually.

Portrait

Blurs the background to make the subject stand out.

Sports

Captures fast moving subjects.

Low Light

Brightly captures subjects in dark locations.

Spotlight

Captures subjects illuminated by a spotlight beautifully.

Note



- In **Portrait**, **Sports**, **Low Light**, and **Spotlight**, the exposure (iris, shutter speed, gain, etc.) settings are adjusted automatically. In the [WB/Color] tab, only [White Balance Mode] and [Color Temperature (K)] are displayed. The [Image Quality] tab and the [Image Quality Details] tab cannot be selected.
- In **Portrait** and **Sports**, the captured video may not appear smooth or may flicker.
- For precautions regarding shooting in **Tv** (Shutter Priority AE) and **Low Light**, refer to "About Shooting with Slow Shutter" (P. 39).

- The items that can be set differ depending on the shooting mode. The details are shown below.

○: Items which can be set

●: Items which are set automatically

–: Items which cannot be set

Item	Shooting Mode					 
	F.Auto	P	Tv	Av	M	
Infrared* ¹	○	○	○	○	○	○
Enhanced ND filter	○	○	○	○	○	○
Iris	●	●	●	○	○	●
ND Filter	●	○* ²	○* ²	○* ³	○* ³	●
Shutter Mode	●	●	○* ⁴	●	○	●
Gain	●	●	●	●	○	●
AGC Limit	–	○	○	○	○	–
AE Shift	–	○	○	○	○* ⁵	–
Metering Mode	–	○	○	○	○	–
AE Response	–	○	○	○	○	–
Iris Limit	○	○	○	○	○	○
Flicker Reduction	○	○	○	○	○	○
Auto Slow Shutter	○	○	–	–	–	–

*1 When set to [On], shooting mode cannot be set.

*2 Possible to select [Auto] or off.

*3 Linked to the iris settings.

*4 Possible to set the shutter speed.

*5 Possible only if one of Iris, Shutter Mode and Gain is set to [Auto].

[Infrared]

Select whether to perform infrared shooting. In infrared shooting, since the near-infrared light sensitivity is higher compared to normal shooting, it is possible to shoot brightly even the dark scenes.

Note

- When the infrared is [On], the following items cannot be set.
 - [Exposure] > [Enhanced ND Filter], [Iris (Aperture Value)], [ND Filter], [Shutter Mode], [Gain (dB)], [AGC Limit], [AE Shift], [Metering Mode], [AE Response], [Iris Limit]
 - [WB/Color]
 - [Image Quality]
 - [Image Quality Details]
 - [Focus] > [Face Detection AF], [AF Speed]
- When the infrared is [On] in manual focus, the focus will be fixed once in auto focus, then return to manual focus.
- Depending on the light source, auto focus may not function properly during zoom operation.
- Because of the significantly increased near-infrared sensitivity in infrared shooting, no strong light or heat source should be turned toward the lens when switching to infrared shooting.

[Enhanced ND Filter]

Select whether to use the enhanced ND filter. The enhanced ND filter allows to open the aperture for a video with shallow depth of field even in a bright environment. This is also convenient for avoiding blur caused by narrowing down the aperture.

Note

In infrared shooting, the [Enhanced ND Filter] is fixed to off.

[Iris (Aperture Value)]

Adjusts the iris (aperture) according to the brightness of the subject.

When [Auto] is set, the iris is automatically adjusted.

When [Auto] is off, the iris can be manually adjusted. Moving the slider to the left opens the aperture and brightens the video. Moving it to the right narrows the aperture and darkens the video.

Following aperture values can be set.

F1.8, F2.0, F2.2, F2.4, F2.6, F2.8, F3.1, F3.4, F3.7, F4.0, F4.4, F4.8, F5.2, F5.6, F6.2, F6.7, F7.3, F8.0, Closed*

* When the Iris is set to manual and the [Iris Limit] is off.

The aperture value that can be set differs depending on the zoom position. Reference aperture value is displayed on the screen.

Maximum wide angle: F1.8 to F8.0, maximum telephoto: F2.8 to F8.0

 **Note**



- To make the subject stand out by changing the depth of field and blur the background or surroundings, set a smaller aperture value , and to keep everything from close objects to far-away objects in focus, set a larger aperture value.
- When shooting in a bright location, narrowing down the iris can cause blurring. It is possible to prevent blurring by adjusting the ND filter and shutter speed and opening the iris.
- When [AUTO] of the iris is set to off, the aperture value from Auto will be retained. The aperture value before setting to [AUTO] will not be restored.
- In infrared shooting, iris is fixed open.

[ND Filter]

When the [Shooting Mode] is set to **Av** (Iris Priority AE) or **M** (Manual Exposure) and the [Iris (Aperture Value)] is F4.0 or larger, ND filter is automatically adjusted linked to the setting of the iris and its value will be displayed. In other shooting modes, when [Iris (Aperture Value)] is F4.0 or larger, the exposure is automatically adjusted using the ND filter.

In **Av** (Iris Priority AE), **M** (Manual Exposure), **P** (Program AE), or **Tv** (Shutter Priority AE), in order to adjust the exposure without using the ND filter, [Auto] can be set to off.

 **Note**

- When the [Shooting Mode] is set to **FAuto** (Full Auto),  (Portrait),  (Sports),  (Low Light), or **A** (Spotlight), ND filter is always automatically adjusted.
- The displayed value reflects the effect of the enhanced ND filter.
- In infrared shooting, ND filter cannot be set.

[Shutter Mode]

Adjusting the shutter speed enables to adapt to the subjects and the shooting environment, making it possible to capture fast-moving subjects (sports, vehicles, etc.) clearly and brighten low-light scenes, etc. Shutter speed can be adjusted in the following modes:

[Auto (sec.)]

Automatically adjusts the shutter speed according to the brightness of the video.

[Speed (sec.)]

Sets the shutter speed to seconds. The shutter speed can also be set to a value higher than the frame rate.

[Slow (sec.)]

Sets the shutter speed slower than the frame rate to seconds. This setting is used for shooting in low-light areas. Also, special effects such as "blurring the background" and "adding residual image effects to zoom" are available for shooting a moving subject with pan operation.

For precautions when shooting in slow, refer to "About Shooting with Slow Shutter" (P. 39).

[Clear Scan (Hz)]

Sets the shutter speed by frequency. This is used to reduce black bands on the screen and flickering from fluorescent lighting, or to fine tune the brightness.

The shutter speed that can be selected differs depending on the frame frequency.

Shutter Mode	Frame Frequency (Hz)				
	23.98	29.97	59.94	25.00	50.00
Auto (sec.)	1/24 - 1/2000	1/30 - 1/2000	1/60 - 1/2000	1/25 - 1/2000	1/50 - 1/2000
Speed (sec.)	1/24 - 1/2000	1/30 - 1/2000	1/60 - 1/2000	1/25 - 1/2000	1/50 - 1/2000
Slow (sec.)	1/6, 1/12	1/8, 1/15	1/8, 1/15, 1/30	1/6, 1/12	1/6, 1/12, 1/25
Clear Scan (Hz)	23.98 - 250.38	29.97 - 250.38	59.94 - 250.38	25.00 - 250.40	50.00 - 250.40

Note

- When the [Shooting Mode] is set to **Tv** (Shutter Priority AE), the shutter speed value can be set as follows according to the frame frequency.
 - At 23.98, 25.00, or 50.00 Hz: 1/6 to 1/2000 sec.
 - At 29.97 or 59.94 Hz: 1/8 to 1/2000 sec.
- In infrared shooting, shutter speed cannot be set.

[Gain (dB)]

Able to set the amplification amount of the video amplifier.

When [Auto] is set, the gain is automatically adjusted. By setting the [AGC Limit], the maximum gain can be limited.

When [Auto] is off, the gain can be manually adjusted. The adjustment range is 0.0 to 36.0 dB (by 0.5).

Note

- Increasing the gain may cause a slightly grainy screen. Also, uneven colors, white dots, and vertical lines may appear on the screen.
- In infrared shooting, gain cannot be set.

[AGC Limit]

Able to suppress the occurrence of grainy screen, uneven colors, white dots, vertical lines, etc. by limiting the maximum value when the gain is set to [Auto].

The adjustment range is 0.0 to 36.0 dB (by 0.5).

Note

- When the shooting mode is **FAuto** (Full Auto), the [AGC Limit] value will not be applied. It will be limited by the maximum value of 24.0 dB.
- In infrared shooting, AGC limit cannot be set.

[AE Shift]

When one of the [Iris (Aperture Value)], [Shutter Mode] or [Gain (dB)] is set to auto, the exposure can intentionally be compensated to capture subjects either at a brighter or darker exposure.

Move the slider to a negative value to darken the image, or to a positive value to brighten it.

Adjustment can be made in the range of -2 levels to +2 levels (by 0.25).

Note

In infrared shooting, AE shift cannot be set.

[Metering Mode]

When one of the [Iris (Aperture Value)], [Shutter Mode] or [Gain (dB)] is set to Auto, and the metering mode is set to match the shooting scene, it is possible to shoot with more appropriate brightness.

[Standard]

Meters the entire screen while focusing on the subject in the center of the screen.

[Backlight]

Controls darker areas of the screen more brightly when shooting backlight scenes.

[Spotlight]

Controls the brightness of the subject to be optimal in the spotlight.

Note

In infrared shooting, metering mode cannot be set.

[AE Response]

Select the response of AE when one of the [Iris (Aperture Value)], [Shutter Mode] or [Gain (dB)] is set to Auto.

The set values are High, Normal, and Low in order of the shortest time to achieve the proper exposure.

Note

In infrared shooting, AE response cannot be set.

[Iris Limit]

By setting [Iris Limit] to off and iris to [Closed], the black balance can be adjusted under dark conditions.

Note

In infrared shooting, iris limit cannot be set.

[Flicker Reduction]

Setting [On] automatically detects and corrects flickering from fluorescent lights.

Note

- Erroneous flicker detection may cause horizontal noise. In this case, avoid using [Flicker Reduction].
- When the frame frequency is 23.98 Hz, the flicker reduction setting would not be effective.
- When shooting under an artificial light source such as a fluorescent lamp, mercury lamp, or halogen light, flicker may occur in principle depending on the shutter speed set. It may be possible to suppress flicker by setting the shutter speed according to the frequency of the power supply. For 50 Hz, select 1/50 second* or 1/100 second; for 60 Hz, select 1/60 second or 1/120 second.
* Not available depending on the frame frequency.

[Auto Slow Shutter]



When shooting in a place with insufficient light (such as a room with low light), slows down the shutter speed automatically and adjusts to make the video brighter.

Possible to set when the shooting mode is  (Full Auto) and  (Program AE).

Note

- The slowest shutter speed for each frame frequency differs as follows.
At 23.98 Hz: 1/12 sec.
At 29.97 Hz: 1/15 sec.
At 59.94 Hz: 1/30 sec.
At 25.00 Hz: 1/12 sec.
At 50.00 Hz: 1/25 sec.
- Auto slow shutter cannot be used under the conditions below.
 - When AGC limit is enabled
 - When frame frequency is 23.98 Hz, 29.97 Hz, or 25.00 Hz, and [Focus] > [Face Detection AF] is [Face Det. & Tracking] or [Face Only]
- For the precautions when shooting with auto slow shutter, refer to the following section "About Shooting with Slow Shutter".

■ About Shooting with Slow Shutter

By setting the [Shooting Mode] to  (Manual Exposure) or  (Shutter Priority AE) to set a slow shutter speed, setting it to  (Low Light), or setting the [Auto Slow Shutter] to [ON], it is possible to shoot the subject brightly even where the light is insufficient. However, depending on the scene or the subject, the following may occur.

- Noticeable residual image from moving subjects
- Deterioration of image quality
- White spots on the screen
- Autofocus not functioning well

WB/Color Settings

Setting the white balance and color matrix settings.

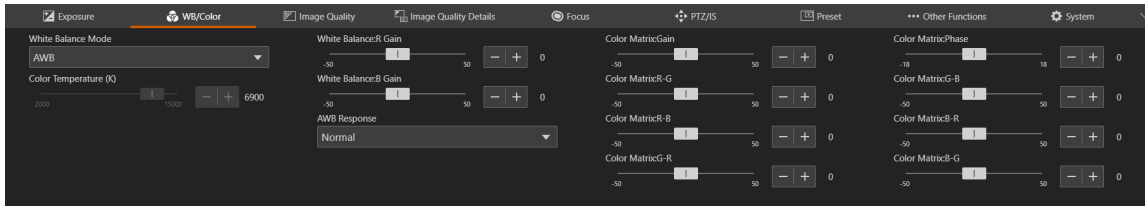

Note

- When [Exposure] > [Shooting Mode] is **F.Auto** (Full Auto), [White Balance Mode] is AWB fixed.
- When [Exposure] > [Shooting Mode] is **Portrait**, **Sports**, **Low Light**, or **Spotlight**, only [White Balance Mode] (AWB fixed) and [Color Temperature (K)] are displayed.
- When [Exposure] > [Infrared] is set to [On], [WB/Color] cannot be selected.

[White Balance Mode]

Sets white balance according to the color temperature of light sources such as illuminations and daylight. Adjustment procedure is as follows:

[AWB]

Adjust the white balance so that it is always optimal. The white balance is automatically adjusted as the color temperature of the light source changes.

[Daylight]

Sets the white balance according to the daylight (approx. 5600 K).

[Tungsten]

Sets the white balance according to tungsten lighting (approx. 3200 K). Use this setting when shooting under tungsten or tungsten colored fluorescent lighting.

[Color Temperature (K)]

Specify the color temperature in range of 2000 K to 15000 K to adjust the white balance.

[Manual]

Set [R Gain] and [B Gain] as desired.

[Set A], [Set B]

Captures the reference white color in the actual shooting environment.

Illuminate a gray card or white subject (white paper, etc.) with a light source and click [White Balance Calibration] while the subject fills the screen.

Possible to register two settings: [Set A] and [Set B].

The settings are erased after the camera is restarted or turned off/on, so register the settings as a preset in order to save them.

Note

- When shooting under the following conditions, if the screen color looks unnatural in [AWB], adjust the white balance using [Set A] or [Set B]:
 - Shooting in locations where lighting conditions suddenly change
 - Close-up shooting
 - Shooting a scene with only one color, such as sky, sea, or forest
 - Shooting under mercury lamps and certain fluorescent/LED lights
- If the setting is other than [AWB], and the location or brightness changes or the ND filter is switched, adjust the white balance again.

[White Balance:R Gain]

Adjusts the shift amount of the red tint in the white balance.

[White Balance:B Gain]

Adjusts the amount of blue tint shift in the white balance.

[AWB Response]

Selects the responsiveness when [White Balance] is set to [AWB].

The set values are High, Normal, and Low, in order of the shortest time required to achieve the proper white balance.

[Color Matrix:Gain], [Color Matrix:Phase], [Color Matrix:R-G], [Color Matrix:R-B], [Color Matrix:G-R], [Color Matrix:G-B], [Color Matrix:B-R], [Color Matrix:B-G]

The color matrix allows to fine-tune the tone of the video.

Settings	Adjustment Items
Gain	Color depth
Phase	Hue
R-G	Cyan to green and red to magenta color tones
R-B	Cyan to blue, red to yellow color tones
G-R	Magenta to red and green to cyan color tones
G-B	Magenta to blue and green to yellow color tones
B-R	Yellow to red, blue to cyan color tones
B-G	Yellow to green and blue to magenta color tones

Image Quality Settings

Setting the image quality.

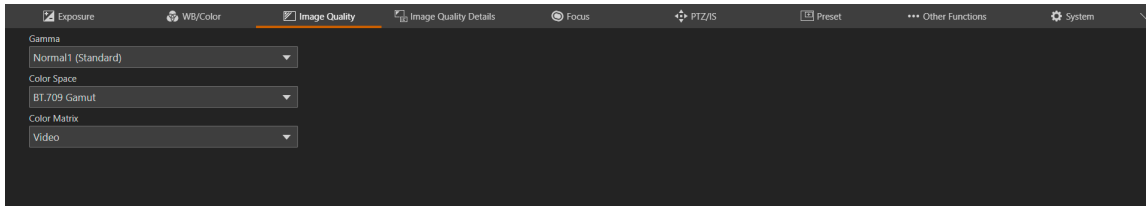

Note

In the following cases, the [Image Quality] tab cannot be selected.

- When [Exposure] > [Shooting Mode] is (Portrait), (Sports), (Low Light), or (Spotlight)
- When [Exposure] > [Infrared] is set to [On]

[Gamma]

Select the gamma curve that determines the overall taste of the video.

[Normal 1 (Standard)]

Use when watching on a TV monitor.

[Normal 3 (BT.709)]

Able to express black gradation in the shadow areas more compared to Normal 1.

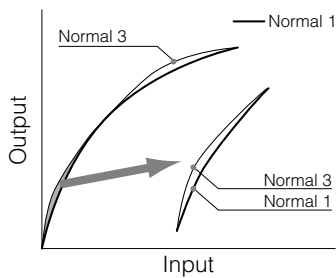

[Color Space]

Select a color space.

[BT.2020 Gamut]

A color space that conforms to the ITU-R BT. 2020 standard specified for UHD TV (4K/8K).
This is the setting for HDMI/SDI output.

[BT.709 Gamut]

A standard color space that conforms to the sRGB standard.

[Color Matrix]

Select a color tone for the video.

[Video]

Realizes color reproduction with contrast suitable for TV broadcasting.

[Neutral]

Faithful color reproduction.

Image Quality Details Settings

Detailed settings related to image quality.

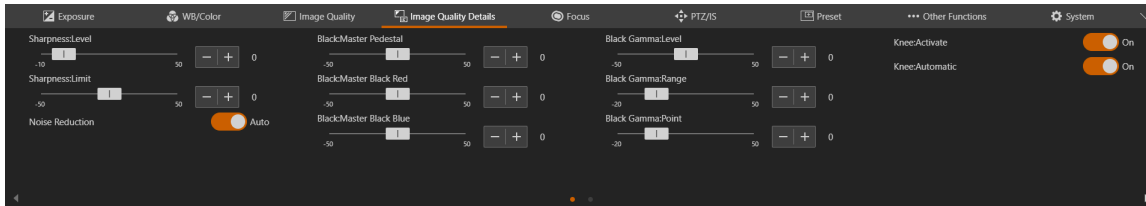

Note

In the following cases, the [Image Quality Details] tab cannot be selected.

- When [Exposure] > [Shooting Mode] is (Portrait), (Sports), (Low Light), or (Spotlight)
- When [Exposure] > [Infrared] is set to [On]

[Sharpness:Level]

Adjust the level of edge enhancement.

[Sharpness:Limit]

Adjusts the level at which the edge enhancement is limited.

[Noise Reduction]

Selects setting method of noise filter to reduce noise.

When [Auto] is turned on, the noise reduction level is automatically set.

When [Auto] is turned off, it is possible to adjust the noise reduction level manually. The higher the value, the greater the noise reduction effect.

[Black:Master Pedestal]

Adjusts the black level.

The higher the value, the vivid the dark area will be and less contrast. Decreasing the number makes the black levels flat.

[Black:Master Black Red], [Black:Master Black Blue]

Corrects R and B individually for black color casts.

[Black Gamma:Level], [Black Gamma:Range], [Black Gamma:Point]

Corrects gamma in shadow areas. By changing each value, the gamma curve on the black side within the range shown in the figure below is adjusted.

- Level: Height from reference gamma
- Range: Width from the point
- Point: Vertex position

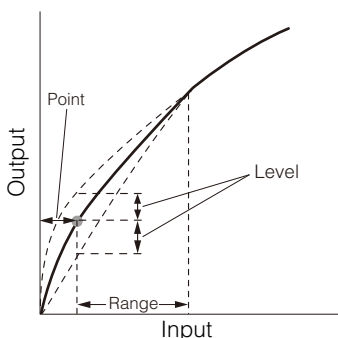

[Knee:Activate], [Knee:Automatic], [Knee:Slope], [Knee:Point], [Knee:Saturation]

Compresses the highlighted areas to suppress the occurrence of blown highlights.

- Activate: Enables knee adjustment.
- Automatic: Enables automatic knee adjustment.
- Slope: Indicates the slope of the knee.
- Point: Indicates the knee point.

- Saturation: Adjusts the color intensity in the highlighted areas.

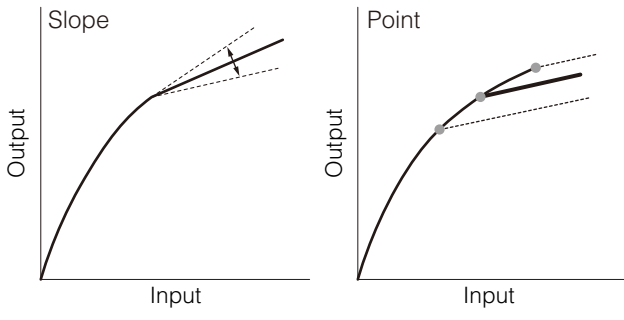

Focus Settings

There are two focus adjustment modes: "Autofocus" and "Manual focus".

Switch the [AF] on in the focus mode to select the autofocus or switch it to off to select the manual focus.

The items that can be set differ depending on the focus mode.

Autofocus

Autofocus adjusts the focus automatically.

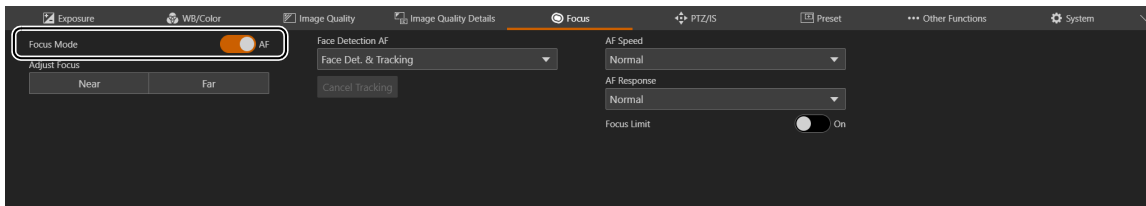

[Focus Mode]

Turning [AF] on switches to autofocus mode.

[Adjust Focus]

Possible to adjust the focus manually even when [AF] is set to on.

Click [Near] to move the focus position to the near side, and [Far] to move the focus position to the far side. Click and hold the button to move continuously. Release the button to return to autofocus.

[Face Detection AF]

Sets the operation of the face detection AF (the ability to detect and focus on a person's face).

[Off]

Focuses on the center of the screen. Face detection is not performed.

[Face Det. & Tracking]

Gives priority to focus on a person's face.

- When there is a person's face in the screen
When multiple people are in the screen, the main subject is automatically determined.
The following face frames are displayed.

Frame representing the main face (if even one face)

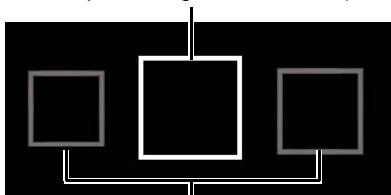

Frames representing non-main faces

Click on a face frame to track that face (P. 46).

- When there is no face in the screen
Focuses on the center of the screen (P. 46).

[Face Only]

Focuses only on the person's face.

If there is a person's face in the screen, follows the procedure described in the previous section, [Face Det. & Tracking].

If there is no person's face in the screen, the focus is locked until a face is detected.

Note

In infrared shooting, the [Face Detection AF] is fixed to [Off].

[Cancel Tracking]

Cancels tracking when tracking a specified subject (P. 46).

[AF Speed]

Selects the autofocus adjustment speed.

[High]

Operates AF at the fastest speed. Effective for high brightness or night view. Uses the external sensor at the same time.

[Normal]

Operates more smoothly compared to [High]. Uses the external sensor at the same time.

[Low]

Stable AF operation.

Note

In infrared shooting, AF speed cannot be set.

[AF Response]

Selects the responsiveness of the autofocus.

The setting values are High, Normal, and Low in order of the shortest time until the focus operation starts.

[Focus Limit]

Reduces the time to achieve the focus by limiting the focus range.

When set to [On], the focus range is 60 cm (2 ft.) to ∞ (throughout the entire zoom range). When set to off, the range is 1 cm (0.39 in.; at full wide-angle) to ∞, including the macro area.

■ Clicking on the Screen

By clicking on the person or on the subject in the screen, even if the subject moves, it is possible to continue to focus on as the main subject. This is called tracking.

When [Face Detection AF] is [Off]

The subject in the center of the screen stays in focus and the AF frame will not be displayed.

When [Face Detection AF] is [Face Det. & Tracking]

When clicking on a person's face, a tracking frame appears on the face, and the tracking will be in progress.

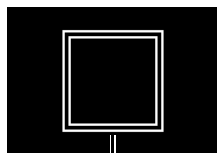

Tracking Frame

If something other than the face of a person is clicked, the tracking frame appears on the subject clicked in the screen and is tracked.

Note

When the tracking frame is displayed, the face frame will not be displayed.

When [Face Only] is selected for [Face Detection AF]

Clicking a person's face is the same as in [Face Det. & Tracking] in the previous section.

If something other than a person's face is clicked, the focus does not change.

■ Autofocus

- The focus position for autofocus varies slightly depending on the shooting conditions such as the subject, brightness, and zoom position. Check the focus again before shooting.
- Focus adjustment can take a while when the frame frequency is 29.97 Hz, 25.00 Hz, or 23.98 Hz.

- It may be difficult to focus with autofocus in certain cases.

Shooting conditions that are difficult to focus with autofocus

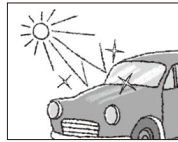

Strong light is reflected.

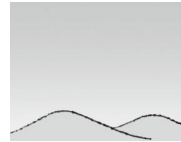

Center of the screen has little light/dark difference.

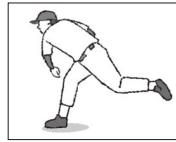

Fast movement

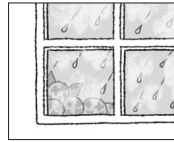

Shooting through glass with water droplets



Night view

- When the iris is narrowed down
- When the shutter speed is in the range of [Slow (sec.)]
- When subjects are at both far and near sides
- The following are the main examples of failure to detect faces:
 - When the face is extremely small, large, dark, or bright relative to the entire screen
 - When the face is facing sideways or diagonally, or upside down
 - When part of the face is hidden
- May detect a subject other than a person as a face by mistake. In such a case, set [Face Detection AF] to [Off].
- May accidentally track another subject with similar characteristics. In this case, select the subject again.
- The conditions under which face detection AF or tracking cannot be used are as follows:
 - In infrared shooting
 - Shutter speed slower than 1/30 sec. (frame frequency at 59.94/29.97 Hz), 1/25 sec. (at 50.00/25.00 Hz), or 1/24 sec. (at 23.98 Hz).
 - When [PTZ/IS] > [Digital Zoom] is set to [400x] and the image size is magnified by more than 80 times
 - When [PTZ/IS] > [Digital Zoom] > [Digital Tele-Converter] is set to [6.0x]

Manual Focus

In Manual Focus, the focus position is moved manually.

By clicking on the video display area, the focus is once automatically adjusted to the position of the mouse pointer that was clicked, and then returns to manual focus.

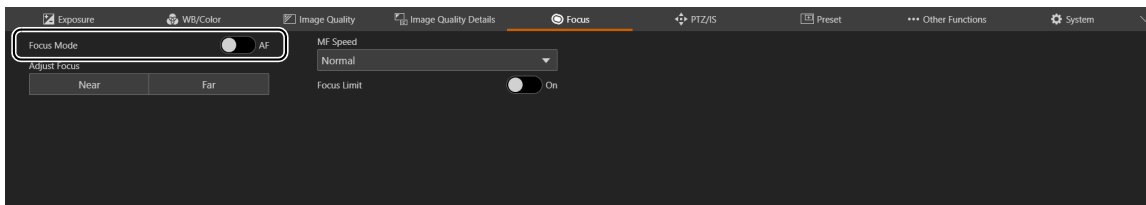

Note

- If a zoom operation is performed after focusing, the focus may shift.
- If the camera is left turned on, the focus may shift due to increase of the temperature of the lens and inside the camera body. Check the focus again before shooting.

[Focus Mode]

Turning [AF] off switches to manual focus mode.

[Adjust Focus]

Click [Near] to move the focus position to the near side, and [Far] to move the focus position to the far side. Click and hold the button to move continuously.

[MF Speed]

Selects the manual focus adjustment speed (amount of focus movement when [Near] or [Far] is clicked.).

[Focus Limit]

The setting is the same as for "Autofocus" (P. 45).

PTZ/IS Settings

Settings for the camera's pan, tilt, and zoom operations and image stabilizer.

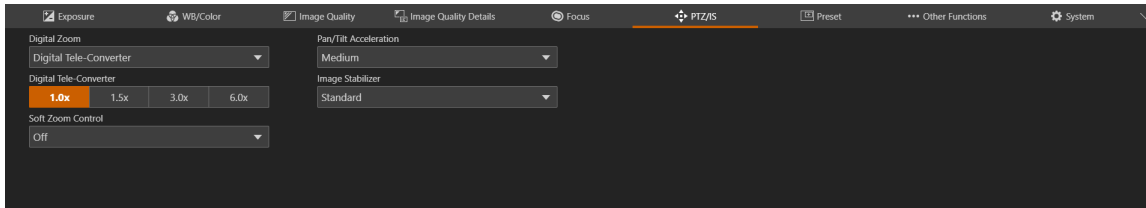

[Digital Zoom]

Select whether to use the digital zoom, or the Digital Tele-Converter.

[Digital Tele-Converter]

When [Digital Zoom] is set to [Digital Tele-Converter], select the magnification of the focal length. Because the image is processed digitally, the video is coarser over the entire zoom range.

[Soft Zoom Control]

Slowly accelerates when zooming starts and decelerates when zooming stops.

[Pan/Tilt Acceleration]

Select the degree of acceleration of the pan/tilt operation.

[Image Stabilizer]

Select whether to use the function that reduces the blurring of videos caused by camera vibration.

[Standard] corrects relatively small blurs.

[Powered IS] corrects blurring during telephoto shooting. The closer the zoom is to the telephoto side, the greater the correction effect. It is not suitable for shooting with pan or tilt.

Note

- If the blurring is too large, it may not be corrected completely.
- When panning or tilting, the anti-vibration effect is smaller than when not operating.
- Swing back may occur when the pan or tilt stops.

Preset Settings

By registering preset camera settings such as camera angle, exposure, and image quality, it is possible to easily call the presets and execute the settings.

Registering Presets

- 1 Click the [Preset] tab on the Settings Page.
Displays the preset settings.
- 2 Click the preset number field to register, and click [Add].

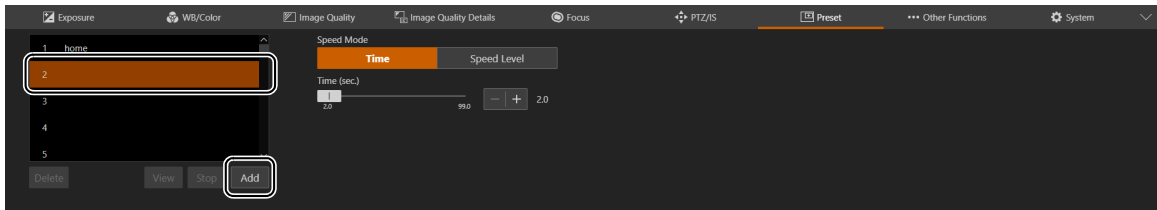

The settings screen will pop up.

- 3 Set the preset items and click [Add].

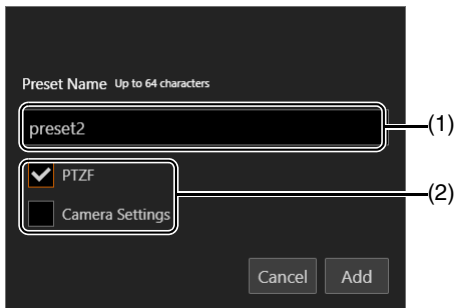

- (1) [Preset Name]
Enter a preset name.
- (2) [PTZF], [Camera Settings]
Check the items to preset.

Item	Preset target
PTZF	Pan/Tilt/Zoom position [Focus] [PTZ/IS] > [Digital Zoom], [Pan/Tilt Acceleration], [Soft Zoom Control]
Camera Settings	[Exposure] [WB/Color] [Image Quality] [Image Quality Details] [PTZ/IS] > [Image Stabilizer]

The preset is saved to the camera and displayed in the list as follows:

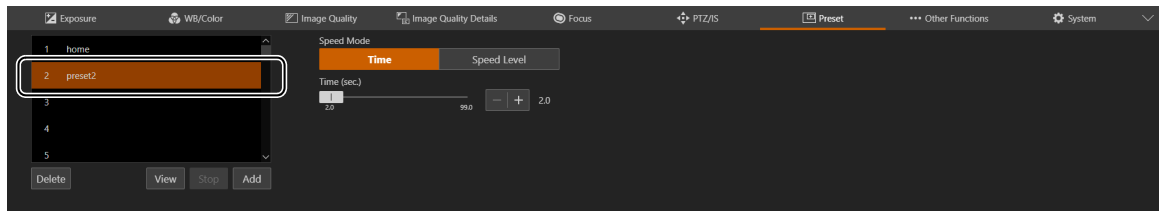

4 Repeat steps 2 to 3 to register multiple presets.

Note

- [home] is the setting when the camera was launched (home position). It can be overwritten but cannot be deleted.
- Able to register up to 100 presets (including home position) in the camera.

Calling Presets

Select the preset to call from the list and click [View] to reflect the preset settings on the camera. Confirm in the video display area.

The time or speed at which the camera moves to the pan/tilt/zoom position can be specified in the [Speed Mode]. Click [Time] or [Speed Level] and adjust the value with the slider, and then click [View].

Note

- If the pan/tilt/zoom or focus of the camera is operated while a preset is running, the preset stops. However, another preset can be called while a preset is running.
- If [Stop] is clicked while a preset is running, the preset stops.
- Depending on the relationship between the pan/tilt/zoom position before the call and the registered pan/tilt/zoom position, and the [Time] setting, it may not operate within the set time.
- Camera settings other than the pan/tilt/zoom position are reflected immediately when [View] is clicked.
- Presets cannot be called while the washer is in operation. Call the preset after the washer operation stops.

Deleting Presets

Select the preset to delete from the list and click [Delete] to delete it from the camera.

Other Functions Settings

Performs color bars output, output to external devices, and operation of wiper and washer (sold on the market).

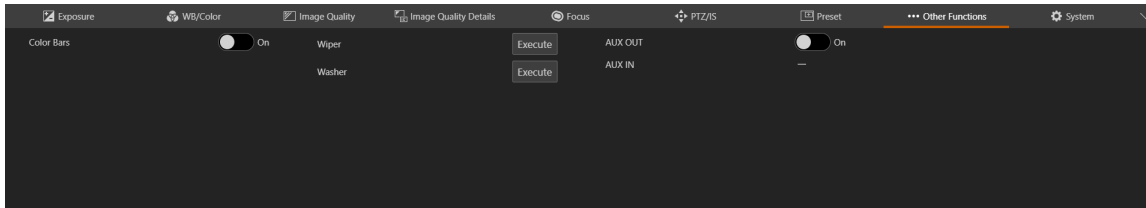

[Color Bars]

Outputs color bars for adjustment of color and brightness of the external monitor.
Set the types of color bars in [System] > [System] > [Camera] > [Color Bar Type].

[Wiper]

Operate the wiper in order to remove the water droplets or dust adhered on the lens protector.
By clicking [Execute], the wiper makes one to-and-fro movement and stops.

[Washer]

Operates a washer (sold on the market).
By clicking [Execute], after sending a signal for water discharge to the washer, the wiper operates. Sends stop signal to the washer during the wiper operation.

Note

Presets cannot be called while the washer is in operation.

[AUX OUT]

Outputs signal to external devices.
Set the operation mode of the output terminal in [System] > [System] > [Camera] > [AUX OUT].

[AUX IN]

Displays the status of the contact input signal from the external device.

: Input active status

: Input inactive status

System Settings

Configure advanced camera system settings such as video and audio, server, communications, and security. If selecting the [System] tab in the settings area, the video display/operation area disappears and the following appears.

Screen Configuration

When [System] tab is clicked, the setting items category is displayed on the left side of the screen, and the setting screen is displayed on the right side.

Categories of the setting items can also be displayed by clicking the  at the upper right of the screen.

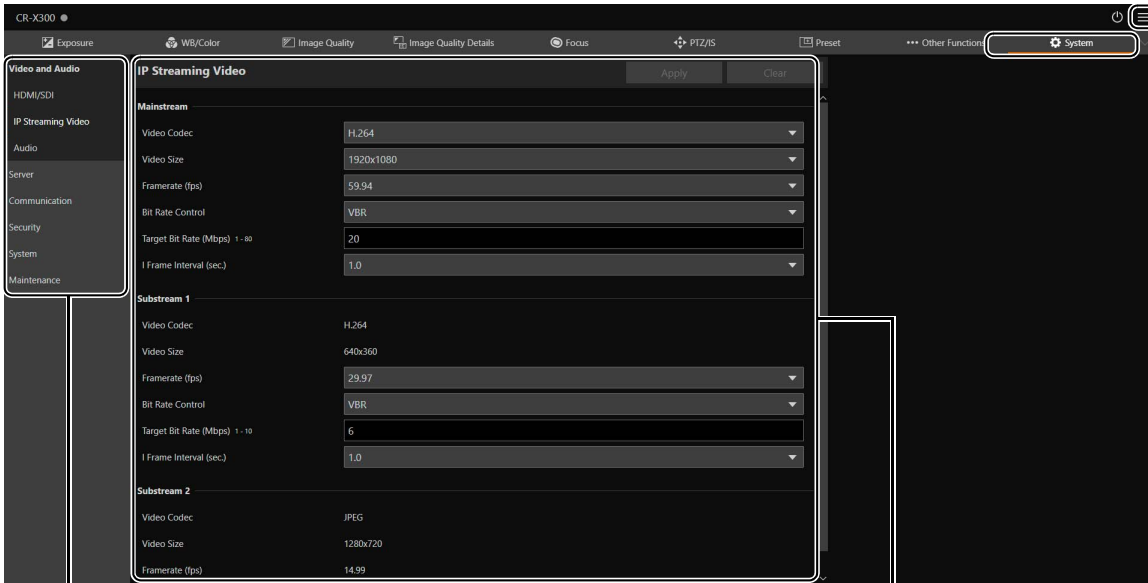

Setting items category

Settings screen

If the width of the screen is narrow, operations must be made from the  menu since the categories of the setting items are hidden.

Setting Items

Following is the overview of each item in the system settings.

Category	Item	Description
Video and audio	HDMI/SDI	Setting the common output signal method for HDMI/SDI and 3G-SDI mapping (P. 55).
	IP Streaming Video	General settings of the video, such as video size and quality sent from the camera (P. 56).
	Audio	Setting input audio from the built-in microphone and the bit rate in the IP audio distribution (P. 58).
Server	HTTP/Video	Setting the HTTP Server and video server (P. 59).
	RTP	Communication setting using RTP Server (P. 60).
Communication	Network	Setting the network to which the camera is connected (P. 62).
	External Connection (IP)	Setting the communication protocol for IP connection of the camera with external devices such as controllers (P. 65).
	External Connection (Serial)	Setting the serial connection of the camera (P. 67).
Security	Certificate Management	Setting the certificate creation and management (P. 69).
	SSL/TLS	Encrypted communications and server certificate settings (P. 70).
	User Management	Adding/deleting administrator account information and authorized users, setting operating privileges (P. 71).
	Host Access Restrictions	Setting separate access controls for access from IPv4 and IPv6 addresses (P. 73).
System	Camera	Setting the camera name, external device output, color bars, Genlock, etc. (P. 75).
	Date and Time	Camera date and time settings (P. 77).
	Environment	Frame frequency settings (P. 79).
	Language	Display language settings (P. 80).
Maintenance	General	Device information and settings, license verification, reboot and initialization settings (P. 81).
	Backup/Restore	Perform backup and restoration (P. 83).
	Update Firmware	Perform firmware update (P. 84).
	Log	Log display and downloading message (P. 85).

Common Operations

Describes common operations in system settings.

Note

If a setting that does not display a dialog in a web browser is enabled, it may not be possible to operate the Settings Page. In this case, close and restart the web browser.

■ Applying Configuration Changes

When a setting is changed on the Settings Page, the [Apply] and [Clear] buttons in the upper right of the Settings Page are no longer grayed out and can be clicked.



In this situation, if [Apply] is clicked, the changed settings will be applied. Click [Clear] to revert to the previous settings.

■ Changes to Settings that Require to Reboot

Settings that require the camera to be restarted for the changed settings to take effect are preceded by a green [Reboot] symbol.



When an item that has a [Reboot] symbol is changed, [Apply] in the upper right of the Settings Page changes to [Apply and Reboot].

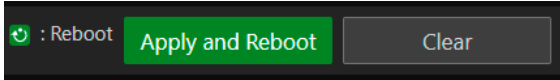

Click [Apply and Reboot] to apply the changes and restart the camera.
Click [Clear] to revert to the previous settings.



Important

If switched to another settings screen without clicking [Apply] or [Apply and Reboot], changes will be lost. Be sure to click [Apply] or [Apply and Reboot] to apply changes.

■ Setting Range and Character Limit

For setting items requiring numeric value input and character input, the allowable range and character limit are displayed.

Enter within the displayed ranges.

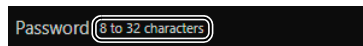

[System] > [Video and Audio] > [HDMI/SDI]

Settings for the video output configuration of the HDMI and SDI terminals.

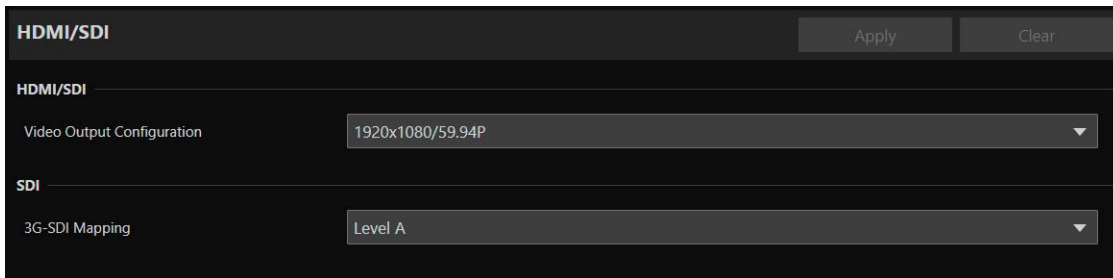

HDMI/SDI Apply Clear

HDMI/SDI

Video Output Configuration: 1920x1080/59.94P

SDI

3G-SDI Mapping: Level A

HDMI/SDI

Settings for the video output configuration to be commonly used for HDMI/SDI.

[Video Output Configuration]

The video output format is set as a combination of the video size and frame rate.

The selectable HDMI/SDI video output configuration varies depending on the [Frame Frequency (Hz)] set in [System] > [System] > [Environment].

Frame Frequency (Hz)	HDMI/SDI video output configuration (video size/frame rate)
23.98	1920x1080/23.98P, 3840x2160/23.98P
29.97	1920x1080/29.97P, 3840x2160/29.97P
59.94	1280x720/59.94P, 1920x1080/59.94P, 1920x1080/59.94i
25.00	1920x1080/25.00P, 3840x2160/25.00P
50.00	1920x720/50.00P, 1920x1080/50.00P, 1920x1080/50.00i

The settings and options for each video stream vary depending on the selected video output configuration. See [System] > [Video and Audio] > [IP Streaming Video] for more information.

[Output Terminal]

When the video size is 3840 x 2160, set the output terminal to HDMI or SDI.

SDI

Settings for the output signal method of the SDI terminal.

[3G-SDI Mapping]

When [Video Output Configuration] is [1920x1080/59.94P] or [1920x1080/50.00P], select the mapping method of the output signal of the SDI terminal. A signal conforming to Level A or Level B of the SMPTE ST 425-1 standard is outputted.

[System] > [Video and Audio] > [IP Streaming Video]

Settings for the general video settings such as size and quality for the video to be distributed via IP. Settings are made for each of the following three streams.

- Mainstream
- Substream 1
- Substream 2

Stream	Video Codec	Video Size	Framerate (fps)	Bit Rate Control	Target Bit Rate (Mbps)	I Frame Interval (sec.)
Mainstream	H.264	1920x1080	59.94	VBR	20	1.0
Substream 1	H.264	640x360	29.97	VBR	6	1.0
Substream 2	JPEG	1280x720	14.99			

The options for [Video Size] and [Framerate (fps)] that can be selected for each video stream vary depending on the frame frequency set in [System] > [System] > [Environment].

Mainstream

Set the Mainstream video to be distributed from the camera.

[Video Codec]

Select the video codec type.

In the following cases, the video codec is fixed to H.264.

- If [System] > [Communication] > [External Connection (IP)] > [NDI|HX] is [Enable],
- If [System] > [Communication] > [External Connection (IP)] > [RTMP] is [Enable],

Note

If [I Frame Interval (sec.)] is set to [ALL-I], [H.265] cannot be set.

[Video Size]

Select a video size.

When the frame frequency is 59.94 Hz or 50.00 Hz, [3840 x 2160] cannot be set.

[Framerate (fps)]

Select the frame rate of the video.

[Bit Rate Control]

Settings for the video bit rate.

In order to control the bit rate strictly such as in an environment subject to the bandwidth limitations, set to [CBR].

[Target Bit Rate (Mbps)]

Enter the target value of the bit rate when [Bit Rate Control] is set to [CBR].

Enter a bit rate as an image quality reference when [Bit Rate Control] is set to [VBR]. Depending on the video, the set bit rate may be exceeded.

The maximum value that can be entered differs depending on the settings of [Video Size] and [Framerate (fps)].

[I Frame Interval (sec.)]

Select the interval (sec.) to insert an I frame into the video selected in [Video Codec]. Specify [ALL-I] if wanting all frames to be I-frames.



Note

When [Video Codec] is set to [H.265], [ALL-I] cannot be set.

Substream 1

Settings for the video of Substream 1 to be distributed from the camera.

[Video Codec]

Fixed to H.264.

[Video Size]

Fixed at 640 x 360.

[Framerate (fps)], [Bit Rate Control], [Target Bit Rate (Mbps)], [I Frame Interval (sec.)]

Refer to each item of [Mainstream].



Note

[Framerate (fps)] of Substream 1 cannot be set to [59.94] or [50.00].

Substream 2

Displays the set value for the video of Substream 2 to be distributed from the camera.

[Video Codec]

Fixed to JPEG.

[Video Size]

Fixed at 120 x 720.

[Framerate (fps)]

The set value is displayed according to the frame frequency.

[System] > [Video and Audio] > [Audio]

Bit rate settings for the audio input from the built-in microphone and for IP audio streaming.

Audio Apply Clear

General Audio

Audio Input Enable

Input Volume 1 - 100 50

Current Volume Level (L)

Current Volume Level (R)

Attenuator Disable

IP Audio Streaming

Distribution Bit Rate (kbps) 128

General audio

Settings for the volume of the audio input and the audio input operation with the built-in microphone.

[Audio Input]

Select whether to use audio from the built-in microphone.

When [Disable] is selected, audio will not be outputted from HDMI/SDI output.

Note

To set [Audio Input] to [Disable], all of the following settings must be changed to [Disable].

- [System] > [Server] > [RTP Server] > Each stream (Main, Sub1, Sub2) > [Audio Transmission]
- [System] > [Communication] > [External Connection (IP)] > [NDI|HX] > [Audio Transmission]
- [System] > [Communication] > [External Connection (IP)] > [RTMP] > [Audio Stream]

[Input Volume]

Settings for the input volume from the built-in microphone.

[Current Volume Level (L)], [Current Volume Level (R)]

Displays the current volume level in the status bar.

[Attenuator]

Select whether to use the attenuator.

IP Audio Streaming

Features settings for IP Audio streaming.

[Distribution Bit Rate (kbps)]

Select the bit rate for distribution.

Important

- Video and audio may not sync.
- Depending on the performance of the computer and the network environment, audio may be interrupted.
- If using antivirus software, audio may be interrupted.
- If communication is temporarily interrupted by reseating of the LAN cable for example, the audio will be disconnected. In this case, reconnect the device to the camera.

[System] > [Server] > [HTTP/Video]

Settings for the HTTP Server for distributing Settings Page and videos over the network, and video distribution via HTTP.

HTTP/Video Reboot Apply Clear

HTTP Server

Authentication Method

HTTP Port

HTTPS Port

Video Server

Maximum Number of Clients

Maximum Connection Time (sec.)

HTTP Server

Settings for the authentication method and HTTP port.

Important

Displays a confirmation dialog if the connection to the camera from the active web browser may become disabled by the changes of the [HTTP port] or [HTTPS port] settings. If the changed settings are to be applied, click [OK].

If unable to reconnect to the camera from the web browser after restarting the camera, a message appears with a suggested URI, if any, to reconnect to the camera.

If unable to connect to the camera through the displayed URI, contact your system administrator.

[Authentication Method]

Select the authentication method to be used by the HTTP Server.

[HTTP Port]

Enter the HTTP port.

In general, use [80] (factory default setting).

[HTTPS Port]

Enter the HTTPS port.

In general, use [443] (factory default setting).

Video Server

Settings for clients which can connect to the Video Server.

[Maximum Number of Clients]

Enter the maximum number of clients that can connect to the camera simultaneously.

If [0] is entered, only the administrator is allowed to connect.

Important

If there are many clients to distribute, the video frame rate may decrease or the audio may be cut off.

[Maximum Connection Time (sec.)]

Enter the maximum time, in seconds, that individual client can connect to the camera.

If [0], the connection time is unlimited.

[System] > [Server] > [RTP]

Settings for video and audio distribution using RTP.

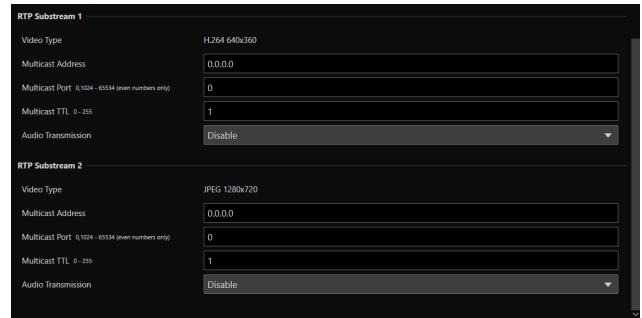
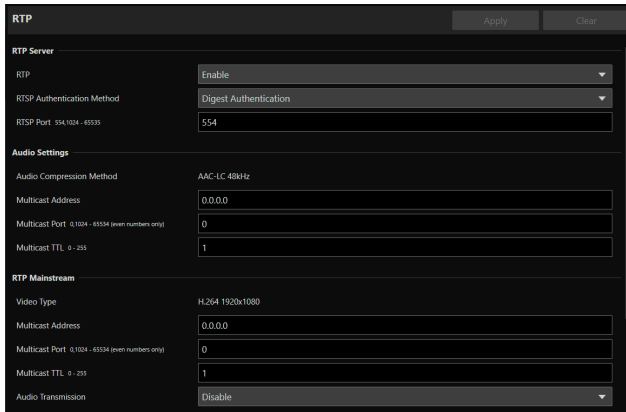

RTP Server

Settings for use of RTP, RTSP authentication method and port number.

[RTP]

Select whether to use RTP.

[RTSP Authentication Method]

Select a RTSP authentication method. Since RTSP authentication method is set independently from HTTP Server authentication method, it is necessary to configure the settings for each authentication method.

[RTSP Port]

Enter the RTSP port.

In general, use [554] (factory default setting).

Audio Settings

Settings for multicast audio transmission.

[Audio Compression Method]

Displays the audio compression method and the frequency. Fixed at AAC-LC 48kHz.

[Multicast Address]

Enter multicast address for audio transmission as follows.

IPv4: in the range of 224.0.0.0 to 239.255.255.255

IPv6: address starting with ff00::/8

[Multicast Port]

Enter multicast port for audio transmission.

[Multicast TTL]

Enter the effective range for multicast distribution.

The TTL (Time To Live), representing the effective range for multicast distribution, is decremented each time the signal passes through a router. When it reaches 0, distribution through a router becomes impossible.

For example, if TTL is set to [1], multicast distribution is confined to the local segment only and cannot pass through the router.



Note

With one of the following settings, audio multicast distribution is disabled.

- Set [0.0.0.0] (IPv4) or [::0(::)] (IPv6) for [Multicast Address].
- Set [0] for [Multicast Port] or [Multicast TTL].

RTP Mainstream, RTP Substream 1, RTP Substream 2

Settings for each stream for RTP stream distribution.

[Video Type]

Displays [Video Codec] and [Video Size] set for each video stream in [System] > [Video and Audio] > [IP Streaming Video].

[Multicast Address]

Enter multicast address for RTP stream as follows.

IPv4: in the range of 224.0.0.0 to 239.255.255.255

IPv6: address starting with ff00::/8

[Multicast Port]

Enter multicast port for RTP stream.

[Multicast TTL]

Enter the effective range for multicast distribution of RTP stream.

The TTL (Time To Live), representing the effective range for multicast distribution, is decremented each time the signal passes through a router. When it reaches 0, distribution through a router becomes impossible.

For example, if TTL is set to [1], multicast distribution is confined to the local segment only and cannot pass through the router.

[Audio Transmission]

Select whether to use the audio transmission of RTP stream.

When [Disable] is set for [System] > [Video and Audio] > [Audio] > [General Audio] > [Audio Input], [Enable] cannot be set.



Note

- With one of the following settings, the multicast distribution of RTP stream is disabled.
 - Set [0.0.0.0] (IPv4) or [::0(::)] (IPv6) for [Multicast Address].
 - Set [0] for [Multicast Port] or [Multicast TTL].
- URL for RTP stream
rtsp://IP address: port/rtpstream/config1(to 3)
Example: rtsp://192.168.100.1:554/rtpstream/config1
 - Distribution method depends on the request for distribution from the RTP client application.
 - config1 requests the distribution of RTP Mainstream, config 2 requests RTP Substream 1, and config 3 requests RTP Substream 2.
- Video quality of Main and Sub1 with [Bit Rate Control], etc. uses the settings in [System] > [Video and Audio] > [IP Streaming Video] (P. 56) .
- [Video Distribution] in [System]> [Security]> [User Management]> [User Authority] is not reflected in RTP.
- In an environment using proxy server or firewall, the video from the RTP stream may not be displayed. In such a case, contact your system administrator.
- When the host access restriction is applied to a client during the RTP over UDP stream distribution, it may take from a few seconds to several tens of seconds to stop the distribution.

[System] > [Communication] > [Network]

Settings for connecting to the network.

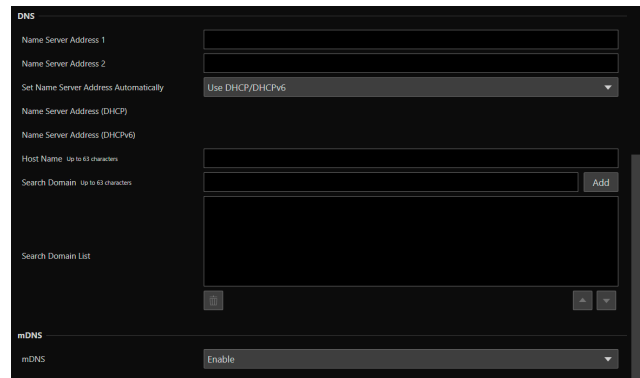
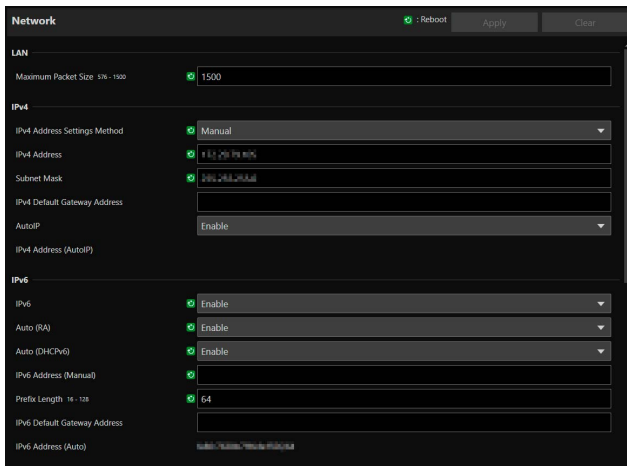

Important

If changing settings related to network connection, it might not be possible to connect to the camera from the web browser. In this case, by clicking [Apply] or [Apply and Reboot], a dialog for confirmation will be displayed. Click [OK] to apply the change. If unable to reconnect to the camera from the web browser after the camera is restarted due to a configuration change, a message appears with a suggested URI, if any to reconnect to the camera. If unable to connect to the camera through the displayed URI, contact your system administrator.

LAN

Settings for the transmission data size from the camera.

[Maximum Packet Size]

Enter the maximum size for the packets transmitted from the camera. In general, it is not necessary to change from 1500. When using IPv6, it is necessary to set 1280 or higher. When using ADSL, by slightly decreasing the value, transmission efficiency may be improved.

IPv4

Settings for connection to the camera over IPv4. IPv4 address can be acquired automatically from the DHCP Server or can be set manually.

Important

- Regarding [IPv4 Address], [Subnet Mask] and [IPv4 Default Gateway Address] for manual setting of IPv4, contact your system administrator.
- If there is any error in the settings of [IPv4 Address], [Subnet Mask] or [IPv4 Default Gateway Address], access via network may not be possible. In such a case, search cameras using the Camera Search Tool, and set the address again.

[IPv4 Address Settings Method]

Select the IPv4 address settings method.

For [Manual], enter a fixed IPv4 address to [IPv4 Address].

For [Auto (DHCP)], a value acquired from DHCP Server will be set automatically to [IPv4 Address (DHCP)] and [IPv4 Default Gateway Address (DHCP)].



Important

When using IPv4 address settings in [Auto (DHCP)], in an environment with a router between the DHCP Server and the camera, IPv4 address may not be assigned correctly. In such a case, select [Manual] to set the fixed IPv4 address.

[IPv4 Address]

When [IPv4 Address Settings Method] is [Manual], enter the fixed IPv4 address.

[Subnet Mask]

When [IPv4 Address Settings Method] is [Manual], enter the subnet mask value specified for each network.

[IPv4 Default Gateway Address]

When [IPv4 Address Settings Method] is [Manual], enter a value. Make sure to set, when connecting the camera to a subnet different from IP connection device such as controller.

[AutoIP]

Select whether to use AutoIP. When the AutoIP address is enabled, IP address automatically set will be displayed in [IPv4 Address (AutoIP)].

IPv6

Settings for connection to the camera over IPv6. IPv6 address can be acquired automatically from the RA or the DHCPv6 Server, or can be set manually.



Important

Regarding [IPv6 Address (Manual)], [Prefix Length] and [IPv6 Default Gateway Address] for manual setting of IPv6, contact your system administrator.

[IPv6]

Select whether to use IPv6.

[Auto (RA)]

Select [Enable], when automatically setting the address using RA (Router Advertisement, network information transmitted automatically from the router).

[Auto (DHCPv6)]

Select [Enable], when automatically setting the address using DHCPv6.

[IPv6 Address (Manual)]

For setting the address manually, enter a fixed IPv6 address.

[Prefix Length]

For setting the address manually, enter a prefix length.

[IPv6 Default Gateway Address]

For setting the address manually, enter a default gateway address. Make sure to set, when connecting the camera to a subnet different from IP connection device such as controller.

[IPv6 Address (Auto)]

When [IPv6] is [Enable] and [Auto (RA)] or [Auto (DHCPv6)] is [Enable], the address automatically acquired will be displayed.

DNS

Settings for the DNS Server address. DNS Server address can be set manually or can be acquired automatically from the DHCP/DHCPv6 Server.

[Name Server Address 1], [Name Server Address 2]

Enter the name server address to be registered. When only one address is to be registered, leave [Name Server Address 2] blank.

Note

If [Name Server Address 1] cannot be used, make access to [Name Server Address 2]. However, it is assumed that [Name Server Address 2] is set beforehand.

[Set Name Server Address Automatically]

Select the server for setting automatically the name server address.

When using DHCP, set [IPv4 Address Settings Method] to [Auto (DHCP)] (P. 62).

When using DHCPv6, set [IPv6] to [Enable] and [Auto (DHCPv6)] to [Enable] (P. 63).

[Name Server Address (DHCP)]

When [Set Name Server Address Automatically] is set as [Use DHCP] or [Use DHCP/DHCPv6], the name server address acquired from the DHCP Server will be displayed.

[Name Server Address (DHCPv6)]

When [Set Name Server Address Automatically] is set as [Use DHCPv6] or [Use DHCP/DHCPv6], the name server address acquired from the DHCPv6 Server will be displayed.

[Host Name]

The host name of the camera can be registered with alphanumeric characters to the name server.

[Search Domain]

When adding a domain name to the search domain list, enter the domain name and click [Add].

If a domain name is specified in the search domain list, it will be handled in the form of host name + domain name simply by specifying the host name without the domain name in the specified server such as NTP and RTMP.

[Search Domain List]

Displays a list of domain names added in [Search Domain].

Queries are sent to the DNS Server in order from the top of the list of domain names.

With the ▲ or ▼ button on the right, the order of the domain names can be changed.

Select a domain name and click  to delete the domain name.

mDNS

Settings for use of multicast DNS. When using mDNS, IP address and host name information of the camera is notified to other hosts on the network.

[mDNS]

Select whether to use mDNS.

For using NDI|HX as a communication protocol (P. 65), set [mDNS] to [Enable].

[System] > [Communication] > [External Connection (IP)]

Settings for communication for connecting controllers, etc. via IP.

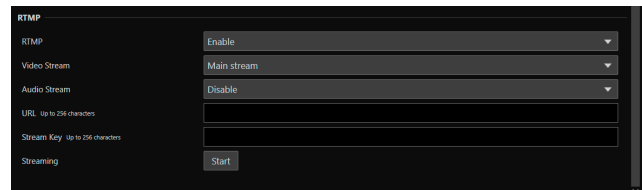
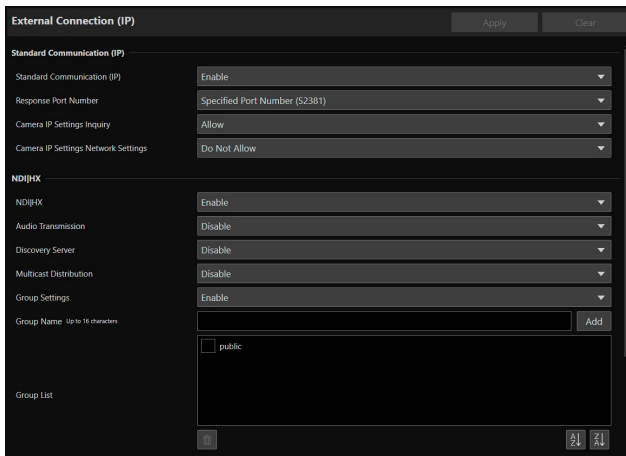

Standard Communication (IP)

Settings for operating the cameras from the controller connected by the standard IP communication.

[Standard Communication (IP)]

Select whether to use [Standard Communication (IP)] for the connection with the controller.

[Response Port Number]

Select whether to use a fixed port number (52381) or a source port number when communicating with the controller.

[Camera IP Settings Inquiry]

Select whether to allow the inquiry on the camera IP settings from the controller.

[Camera IP Settings Network Settings]

Select whether to allow to change the network settings of the camera from the controller.

NDI|HX

Settings for exchanging data with NDI|HX supported devices.

[NDI|HX]

Select whether to use [NDI|HX] as the communication protocol.

For setting to [Enable], go to [System] > [Communication] > [Network] > [mDNS] and select [Enable] (P. 64).

Note

When [System] > [Video and Audio] > [IP Streaming Video] > [Mainstream] > [Video Codec] is set to [H.265], NDI|HX cannot be used.

[Audio Transmission]

Select whether to use the audio transmission.

When [Disable] is set for [System] > [Video and Audio] > [Audio] > [General Audio] > [Audio Input], [Enable] cannot be set.

[Discovery Server]

Select whether to use the Discovery Server.

When set to [Enable], it only notifies the Discovery Server of the IP address and does not notify other hosts of the IP address nor hostname.

[Discovery Server IP Address]

Enter the IP address of the Discovery Server.

[Multicast Distribution]

Select whether to use the multicast distribution.

Note

For multicast distribution, set the multicast distribution enabled in the NDI client side as well.

[Multicast TTL]

Enter the effective range for multicast distribution.

The TTL (Time To Live), representing the effective range for multicast distribution, is decremented each time the signal passes through a router. When it reaches 0, distribution through a router becomes impossible.

For example, if TTL is set to [1], multicast distribution is confined to the local segment only and cannot pass through the router.

[Group Settings]

Select whether to use the group settings.

When a group name to which the camera belongs is specified, the camera connects only to NDI clients with the same group name.

[Group Name], [Group List]

Enter the group name.

By clicking [Add], the entered group name will be displayed in the group list.

Able to sort the list items in ascending order by clicking  and in descending order by clicking .

Select a group in the group list and click  to delete the group.

RTMP

A communication protocol for the streaming playback of video and audio, and sending and receiving the data.

[RTMP]

Select whether to use [RTMP] as the communication protocol.

Note

When [System] > [Video and Audio] > [IP Streaming Video] > [Mainstream] > [Video Codec] is set to [H.265], RTMP cannot be used.

[Video Stream]

Select the type of the video stream. Substream 2 cannot be used.

[Audio Stream]

Select whether to use the audio stream.

When [Disable] is set for [System] > [Video and Audio] > [Audio] > [General Audio] > [Audio Input], [Enable] cannot be set.

[URL]

Enter the URL of the server set on the distribution server side.

Enter the string of characters starting with rtmp:// or rtmps://.

[Stream Key]

Enter the stream key set on the distribution server side.

[Streaming]

By clicking [Start] to start the streaming, the button becomes [Stop].

By clicking [Stop], the streaming ends.

[System] > [Communication] > [External Connection (Serial)]

Settings for communication by the serial connection of controllers, etc.

External Connection (Serial)	
: Reboot Apply Clear	
Serial Port	
Protocol	Standard Communication (Serial)
Serial Port Connection Type	RS422
Baud Rate (bps)	9600
Data Length (bit)	8
Start Bit (bit)	1
Stop Bit (bit)	1
Parity	None
Standard Communication (Serial)	
Serial Device Address	Auto

Serial Port

Detail settings for the serial port.

[Protocol]

Select either the [NU] protocol or [Standard Communication (Serial)] protocol to be used with the serial port. Set to [None], if the serial port is not used.

Note

To connect the Remote Camera Controller RC-IP100 by serial connection, set to [NU].

[Serial Port Connection Type]

Fixed to RS-422.

[Baud Rate (bps)]

Select the Baud Rate value.

Note

When the [Protocol] is set to [NU], [Baud Rate (bps)] will not be displayed.

[Data Length (bit)]

Data length of serial communication is fixed at 8 bit.

[Start Bit (bit)]

The length of the start bit is fixed at 1 bit.

[Stop Bit (bit)]

The length of the stop bit is fixed at 1 bit.

[Parity]

The settings for the error detection code is fixed to None.

Standard Communication (Serial)

Settings for connection with standard serial communication.

[Serial Device Address]

Select the address of the camera.

When [Auto] is selected, addresses will be automatically assigned.

[System] > [Security] > [Certificate Management]

Managing the server certificates. It is also possible to create a self-signed certificate to use, for example, for operation test.

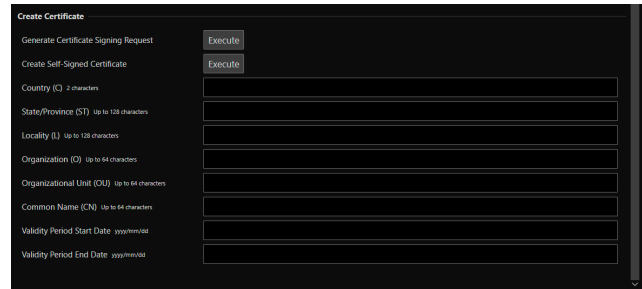
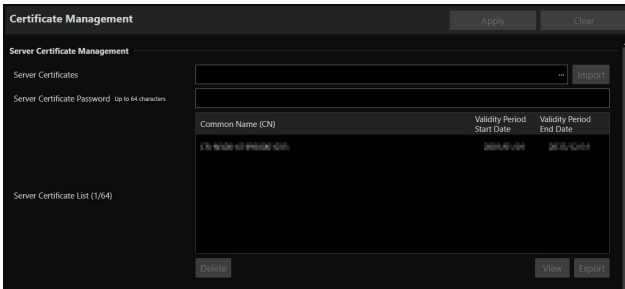

Server Certificate Management

Managing the server certificates.

[Server Certificates]

Imports server certificates.

Click [...] and specify the certificate file to be imported, and then click [Import].

[Server Certificate Password]

Set the password to use when importing and exporting the server certificate.

[Server Certificate List]

Click [View] to display the information of server certificates as a list. Certificate's validity is displayed in GMT (Greenwich Mean Time).

Select the certificate and click [Export] to export the certificate information. Click [Delete] to delete it from the list.

Create Certificate

Creates server certificates.



Important

It is advised to use self-signed certificates for cases such as operation tests that do not require full security. It is recommended to acquire and install a server certificate issued from CA for a full-scale system operation.

[Generate Certificate Signing Request]

Click [Execute] to create a server private key and generate a certificate signing request.

Once processed, the certificate signing request will be displayed in a separate window.

[Create Self-Signed Certificate]

Enter the following items, click [Apply], and click [Execute] to create a self-signed certificate.



Note

Creating a certificate takes time, so it is recommended to stop the video distribution processes etc.

[Country (C)]

Enter the ISO3166-1 alpha-2 country code.

[State/Province (ST)], [Locality (L)], [Organization (O)], [Organizational Unit (OU)], [Common Name (CN)]

Enter state/province name, locality name, organization name, organizational unit name and common name in alphanumeric characters (spaces or printable characters).

Enter an FQDN format host name, etc. to set the common name (required).

[Validity Period Start Date], [Validity Period End Date]

Set the validity period of the certificate to be created (required when creating a self-signed certificate).

[System] > [Security] > [SSL/TLS]

Settings for encrypted communications and server certificates.

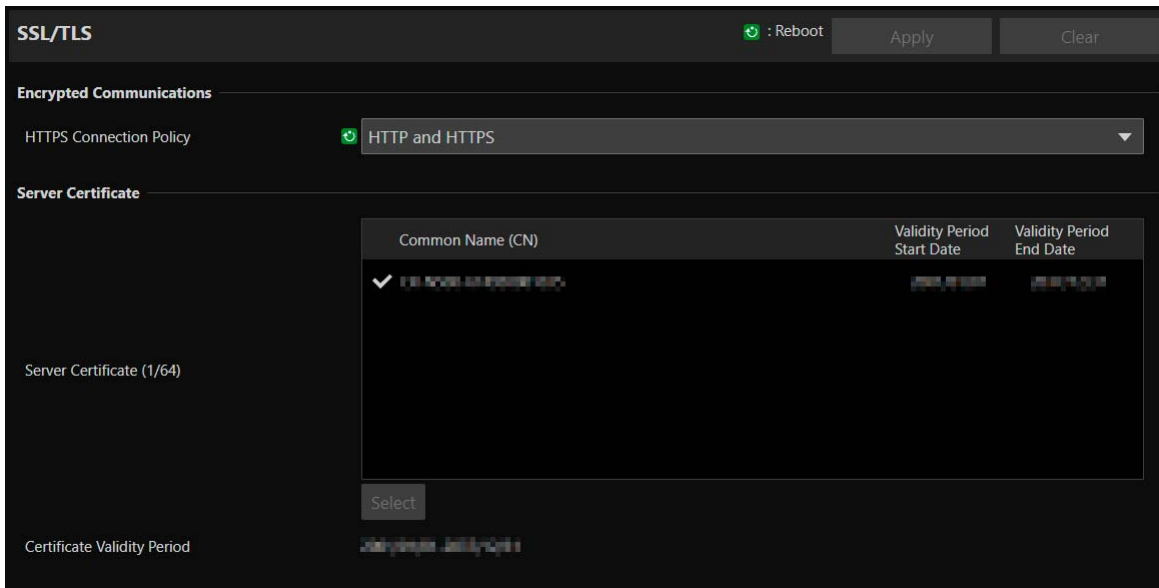

Encrypted Communications

Settings for encrypted communications.

[HTTPS Connection Policy]

Set SSL/TLS communication with HTTPS connections.

Select [HTTP] if SSL/TLS communication is not performed.

Select [HTTPS] or [HTTP and HTTPS] to perform SSL/TLS communication. Connections using SSL/TLS are enabled after rebooting.

If [HTTPS] is selected, HTTP access is also redirected to HTTPS to perform SSL/TLS communication.

Important

- Even if SSL/TLS communication is set to be used here, SSL/TLS communication is not performed unless a certificate has been installed.
- Video distribution performance decreases when performing SSL/TLS communication.

Server Certificates

Settings for server certificate for use.

[Server Certificate]

Select a certificate to use from the certificates registered in [System] > [Security] > [Certificate Management] > [Server Certificate Management], and click [Select]. The selected certificate takes effect after a reboot.

[Certificate Validity Period]

Displays the validity period of the selected certificate.

Note

Depending on the server certificate used by the camera and the computer connected to the camera, it may be necessary to install the root certificate, the intermediate CA certificate, or the certificate selected and exported in [Server Certificate List].

[System] > [Security] > [User Management]

Settings for account to access the camera via an IP connection from a controller, etc.

User Management Reboot Apply Clear

Administrator Account

Administrator Name 5 to 15 characters

Password 8 to 32 characters

Confirm Password 8 to 32 characters

Authorized User Account

User Name 5 to 15 characters

Password 8 to 32 characters

Confirm Password 8 to 32 characters Add

User List

	Camera Control	Video Distribution
Authorized User	<input checked="" type="checkbox"/>	<input checked="" type="checkbox"/>
Guest User	<input checked="" type="checkbox"/>	<input checked="" type="checkbox"/>

"Administrator", "authorized user", and "guest user" are the three types of accounts that are able to access the camera. For the minimum user settings and granting privileges, refer to "Measures Suitable to the Users' Environment 1: User Management" (P. 108).

Administrator:

The administrator can access the Settings Page for all settings including granting privileges to authorized users and guest users. Access the camera with the administrator name and password registered with administrator account.

Authorized User:

This account is used to access the camera by authenticating with a user name and password. It is required to enter a user name and password of the controller or other connecting devices.

Guest User:

The account is used for the device to access the camera without user authentication.

Important

- Multiple administrator accounts cannot connect to a camera at the same time.
- Authorized user and guest user accounts can connect to the camera from multiple devices at the same time.
- When using NDI|HX or RTMP, access cannot be controlled by [User Management].

Administrator Account

Settings for changing the administrator account information that was set at initial setting.

Important

- To ensure system security, set the administrator password that should not be easily guessed by third parties. Be sure not to forget the password.
- If administrator password is forgotten, restore the factory default settings (P. 96). Note, however, that this will reset all camera settings to factory default settings including the administrator account, the network information, date and time.

[Administrator Name]

Enter the administrator name using only alphanumeric characters, hyphens (-), and underscores (_). However, hyphens (-), and underscores (_) cannot be used at the beginning.

[Password]

Enter the administrator password. Use at least two types of alphanumeric characters, numbers, or symbols.

[Confirm Password]

Enter the same password as above for confirmation.

Authorized User Account

Add authorized users.

[User Name], [Password], [Confirm Password]

To add an authorized user, enter the user name and password, then click [Add].

Enter the user name using only alphanumeric characters, hyphens (-), and underscores (_).

Up to 15 authorized users can be added.

For password, use at least two types of alphanumeric characters, numbers, or symbols.

[User List]

Displays a list of added authorized users.

Able to sort the list items in ascending order by clicking  and in descending order by clicking .

Select a user in the list and click  to remove the registered user.

User Authority

Set the privileges for authorized users and guest users. This setting enables to set access restrictions for the Settings Page.

[Camera Control], [Video Distribution]

Confirm the privilege items to be granted to each user.

An authorized user has higher privileges than a guest user.

Important

However, when connected to the RTP server as an authorized user, it is not possible to set restrictions by the user's privilege.

[System] > [Security] > [Host Access Restrictions]

Access control can be performed individually by address to access over the network. Set for IPv4 and IPv6, respectively.

The screenshot shows the 'IPv4 Host Access Restrictions' configuration page. It includes a toggle for 'Apply Host Access Restrictions' set to 'Enable', a 'Default Policy' dropdown set to 'Authorize Access', and a table for 'Network Address/Subnet' with 18 rows. Each row has columns for address, port, and access status, all currently set to '32', '/', and 'Yes' respectively.

01:		32	Yes
02:	/	32	Yes
03:	/	32	Yes
04:	/	32	Yes
05:	/	32	Yes
06:	/	32	Yes
07:	/	32	Yes
08:	/	32	Yes
09:	/	32	Yes
10:	/	32	Yes
11:	/	32	Yes
12:	/	32	Yes
13:	/	32	Yes
14:	/	32	Yes
15:	/	32	Yes
16:	/	32	Yes
17:	/	32	Yes
18:	/	32	Yes

The screenshot shows the 'IPv6 Host Access Restrictions' configuration page. It includes a toggle for 'Apply Host Access Restrictions' set to 'Enable', a 'Default Policy' dropdown set to 'Authorize Access', and a table for 'Prefix/Prefix Length' with 17 rows. Each row has columns for address, port, and access status, all currently set to '128', '/', and 'Yes' respectively.

01:		128	Yes
02:	/	128	Yes
03:	/	128	Yes
04:	/	128	Yes
05:	/	128	Yes
06:	/	128	Yes
07:	/	128	Yes
08:	/	128	Yes
09:	/	128	Yes
10:	/	128	Yes
11:	/	128	Yes
12:	/	128	Yes
13:	/	128	Yes
14:	/	128	Yes
15:	/	128	Yes
16:	/	128	Yes
17:	/	128	Yes

Important

- To prohibit access via a proxy server in HTTP connection, a proxy server address must be set.
- Note that incorrect host restriction settings may prohibit access to the Settings Page itself, and there may be no way to recover other than to revert to factory default settings.

Note

If the same address is set, the setting placed higher in the list will be applied.

IPv4 Host Access Restrictions

Specify the hosts from which IPv4 access is authorized and prohibited.

[Apply Host Access Restrictions]

Select whether to use IPv4 host access restrictions.

[Default Policy]

Select whether to authorize or prohibit access from IPv4 addresses that have not been specified in [Network Address/Subnet].

[Network Address/Subnet]

Enter IPv4 addresses in the list and select [Yes] or [No] for access for each address.

It is possible to specify the subnet to set access restrictions by network or host.

If set to [No], access to all ports is prohibited.

IPv6 Host Access Restrictions

Specify the hosts from which IPv6 access is permitted and prohibited.

[Apply Host Access Restrictions]

Select whether to use IPv6 host access restrictions.

[Default Policy]

Select whether to authorize or prohibit access from IPv6 addresses that have not been specified in [Prefix/Prefix Length].

[Prefix/Prefix Length]

Enter IPv6 addresses (prefixes) in the list and select [Yes] or [No] for access for each address.

It is possible to specify the prefix length to set access restriction by network or host.

If set to [No], access to all ports is prohibited.

[System] > [System] > [Camera]

Settings for camera name, external device output, color bars, Genlock, etc.

Camera Reboot Apply Clear

Camera Name

Camera Name Up to 15 characters

Installation Conditions

Video Flip

Camera Control

Auto Flip

Color Bars

Color Bar Type

AUX OUT

Operation Mode

Tally Lamp

Tally Lamp Control

Tally Lamp Brightness

Genlock

Genlock

Genlock Adjustment -1023 1023 - + 0

Camera Name

Settings for the camera name.

[Camera Name]

Enter an arbitrary camera name.

Installation Conditions

Settings for camera use suitable for the location where the camera will be installed.

[Video Flip]

Select whether to vertically flip the video.

Configure the settings according to the camera installation method, such as ceiling mount or placing on a desk.

Camera Control

Settings for camera control to make the video easier to view

[Auto Flip]

Select whether to use the auto flip function.

In a tilt operation (P. 33), by using the auto flip function, the video display is inverted when the tilted angle approaches 90°.

If the tilt operation is stopped after inverting the video, the tilt operation will be reversed by a ▲▼ button operation. It will be the same when operated by an external device such as a controller.

Note

Even if the video is inverted, the position of the tilt slider will not be inverted, which makes the video and the slider move in the opposite direction.

Color Bars

Sets the types of color bars.

When outputting the color bars, set [Other Functions] > [Color bars] to [On].

[Color Bar Type]

Select either SMPTE compliant, EBU compliant, or ARIB compliant.

AUX OUT

Settings for output operation to external devices.

When outputting to an external device, set [Other Functions] > [AUX OUT] to [On].

[Operation Mode]

Select whether the contact of the output terminal is normally open or close.

If set to [Normally Open], when the contact of the output terminal is closed, an active event occurs, and inactive event occurs when it is opened.

If set to [Normally Close], when the contact of the output terminal is opened, an active event occurs, and inactive event occurs when it is closed.

Normally Open

Active event status

Inactive event status

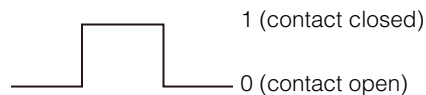

Normally Close

Inactive event status

Active event status

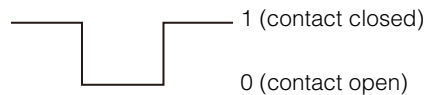

Tally Lamp

Settings for the tally lamp.

[Tally Lamp Control]

Select whether to use tally lamp control.

[Tally Lamp Brightness]

Select the brightness of the tally lamp when [Tally Lamp Control] is set to [Enable].

Genlock

Genlock enables to synchronize the video signals between the camera and the external video device.

Use the GEN-LOCK terminal to input external sync signals (analog black burst signal or HD ternary signal) to the camera.

[Genlock]

Select whether to use Genlock.

[Genlock Adjustment]

Adjusts the H phase of the genlock in the range of approximately ± 0.4 H around the phase difference 0.

Note

- When a synchronizable Genlock signal is inputted, synchronization will stabilize after approximately 10 seconds.
- If an incorrect Genlock signal is inputted, synchronization may not be stable.

[System] > [System] > [Date and Time]

Settings for date and time of the camera.

Date and Time [Apply] [Clear]

Current Date and Time

Date: yyyy/mm/dd

Time: hh:mm:ss

Settings

Settings Method: Synchronize with NTP server

Set NTP Server Settings Automatically: Disable

NTP Server: XXXXX

Synchronization Interval (minutes): 60

Last Sync Time:

Time Zone: (GMT+09:00) Osaka, Sapporo, Tokyo

Daylight Saving Time: Disable

Current Date and Time

Displays the date and time set in the camera.

Settings

It is possible to change the date and time setting method, time zone and daylight saving time set at the initial setting.

[Settings Method]

Select the date and time setting method.

[Set manually]

Set the desired date and time in [Date] and [Time].

Set the time in 24-hour format in <hour:minute:second> order.

[Synchronize with NTP server]

Synchronizes the camera's time with the time of NTP server specified in the [Set NTP Server Settings Automatically] which appears.

[Set NTP Server Settings Automatically]

Select one of the following setting methods:

[Disable]

Enter the IP address or host name of the NTP server in [NTP Server].

[Use DHCP]

Synchronizes the camera's time with the time of the NTP server whose address is acquired from the DHCP server. The acquired NTP server address is displayed in [NTP Server (DHCP)].

For this setting, it is necessary to set [System] > [Communication] > [Network] > [IPv4] > [IPv4 Address Settings Method] to [Auto (DHCP)] (P. 62).

[Use DHCPv6]

Synchronizes the camera's time with the time of the NTP server whose address is acquired from the DHCPv6 server. The acquired NTP server address is displayed in [NTP Server (DHCPv6)].

For this setting, it is necessary to set [System] > [Communication] > [Network] > [IPv6] > [IPv6] to [Enable], then set [Auto (DHCPv6)] to [Enable] (P. 63).

[Use DHCP/DHCPv6]

Synchronizes the camera's time with the time of the NTP server whose address is acquired from the DHCP server or DHCPv6 server.

If the NTP server address can be acquired from both the DHCP server (IPv4) and DHCPv6 server, the NTP server address acquired from the DHCP server (IPv4) will be used.

[Synchronization Interval (minutes)]

Enter the query interval for the set NTP server.

[Last Sync Time]

Displays the time last synchronized with the set NTP server.

[Synchronize with computer time]

Synchronizes the date and time with the time of the computer currently accessing the camera. After clicking [Apply],

[Settings Method] will change to [Set manually].

[Time Zone] is not automatically selected, so set it if necessary.



Note

If the connection with the NTP server cannot be established, for example because the IP address of the NTP server is incorrect, the [Last Sync Time] will not be updated or will be left blank.

[Time Zone]

Select the appropriate GMT (Greenwich Mean Time) time difference.

When the time zone is changed and [Apply] is selected, the date and time will be automatically changed based on the selected time zone.

[Daylight Saving Time]

Select whether to automatically adjust for daylight saving time according to the time zone.

[System] > [System] > [Environment]

Settings for the frame frequency.

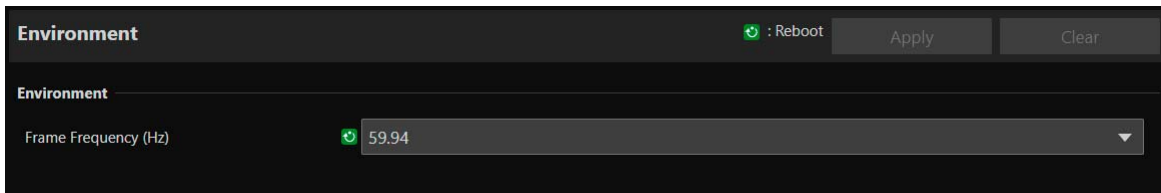

Environment

Setting the frame frequency.

[Frame Frequency (Hz)]

It is possible to change the frame frequency set in the initial settings. The choices of the HDMI/SDI output signal format and the frame rate of the IP streaming video are determined according to the frame frequency. Also, since the choices of [Exposure] > [Shutter Mode] > [Slow (sec.)] could change, confirm the settings of the presets if any.

[System] > [System] > [Language]

Set the language to be displayed on the Settings Page.



The screenshot shows a dark-themed settings interface. At the top, the word "Language" is displayed in a bold, light-colored font. Below this, there is a label "Language" followed by a horizontal line. Underneath the line, the word "Language" is repeated, followed by a dropdown menu. The dropdown menu is currently set to "English" and has a small downward-pointing arrow on its right side.

Language

Select the display language.

[System] > [Maintenance] > [General]

Checking camera information such as the firmware version, and performing maintenance on the camera system.

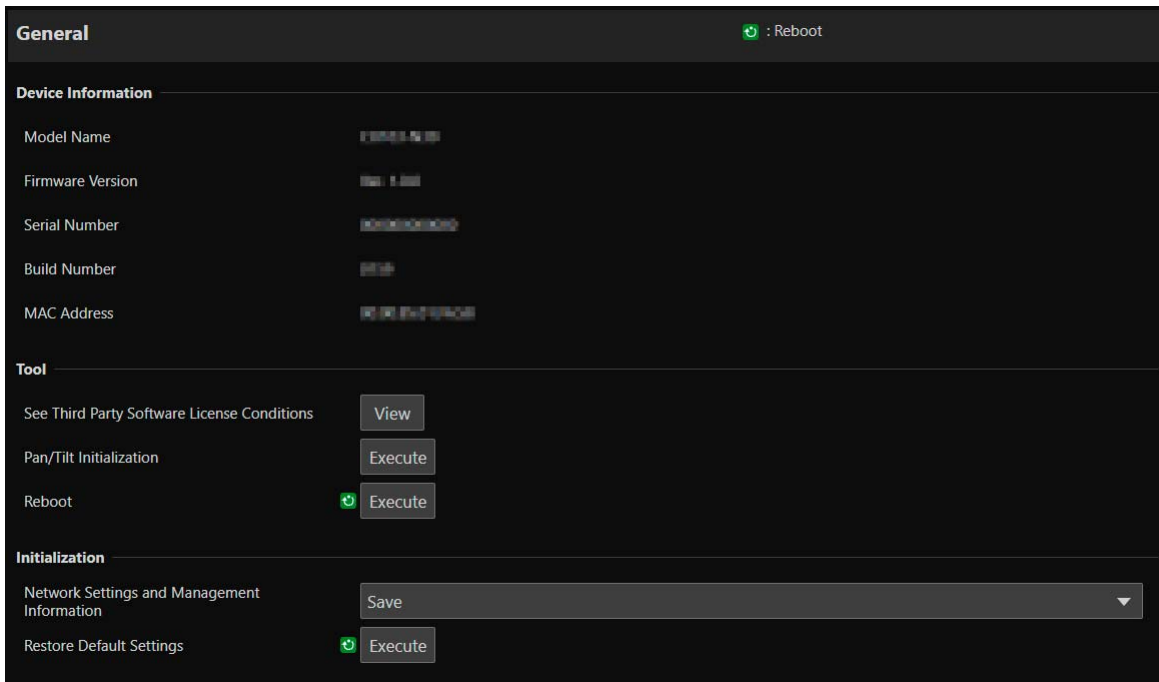

Device Information

[Model Name], [Firmware Version], [Serial Number], [Build Number], [MAC Address]

Displays information about the camera.

Tool

Displays license, initializes the pan/tilt settings, and reboots the camera.

[See Third Party Software License Conditions]

Displays the third party software license information as a list.

[Pan/Tilt Initialization]

If the pan/tilt position shifts, click [Execute] to initialize the position.

[Reboot]

Reboots the camera.

Initialization

Initializing the camera.

Important

- Do not turn off the power to the camera while performing [Restore Default Settings]. Turning off the camera may prevent the camera from starting correctly.
- Once [OK] is clicked, the process of restoring the default settings cannot be interrupted.

[Network Settings and Management Information]

When set to [Save], initialization will be performed except for the following settings.

- Network Settings
- NTP Server
- HTTP Server
- Host Access Restrictions
- Time Zone
- Certificates
- SSL/TLS
- Administrator Name
- Administrator Password

When set to [Do not save], all the settings will be initialized except camera's date and time.

Since the network settings will be initialized, it will not be possible to connect to the camera. Use the Camera Search Tool to configure the default settings.

[Restore Default Settings]

After rebooting, according to the setting in [Network Settings and Management Information] to restore the default settings.



Note

- Before clicking [Execute] in [Restore Default Settings], it is recommended to back up the current settings.
- It is possible to restore the factory default settings by using the RESET switch, but be aware that all the settings except the camera date and time will be restored to the factory default settings (P. 96).

[System] > [Maintenance] > [Backup/Restore]

Saving/Restoring all the camera settings.

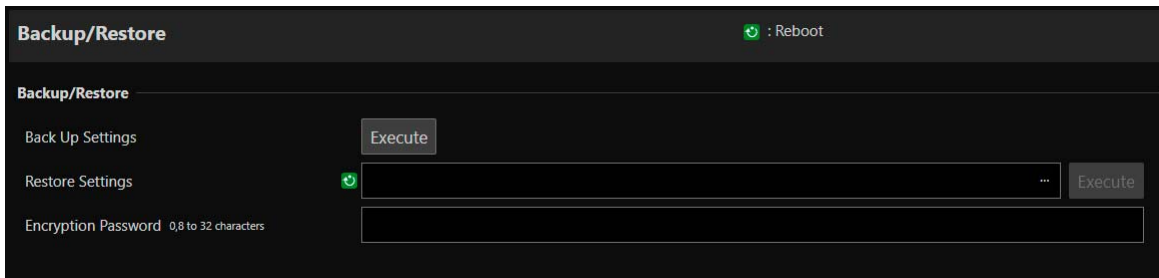

Backup/Restore

Settings related to backup and restore.

Important

Do not turn off the power to the camera while performing [Back Up Settings] or [Restore Settings]. Turning off the camera may prevent the camera from operating correctly.

[Back Up Settings]

All settings except date and time will be backed up. The administrator account and certificates used in SSL/TLS, including private key will be backed up.

[Restore Settings]

Restores all settings, except date and time, from the backup file created in [Back Up Settings]. The administrator account, IP address and certificates used by SSL/TLS, including private key will be restored. After restoring, the camera will be rebooted.

Important

- Be aware that if restored from a backup file of another camera, problems such as duplication of addresses on the network or overwriting of a different Administrator Password may occur, preventing the connection to the camera.
- When restoring the settings, do not use a backup file created with a newer version of firmware than that of the camera to restore.

[Encryption Password]

It is possible to set a password for backup and restore. This password is for encrypting the backup data itself. Use at least two types of alphanumeric characters, numbers, or symbols.

When restoring from encrypted backup data, enter the password set when backing up.

Note

The settings are not restored if the password set when backing up and the password set when restoring do not match.

[System] > [Maintenance] > [Update Firmware]

Updating the firmware.

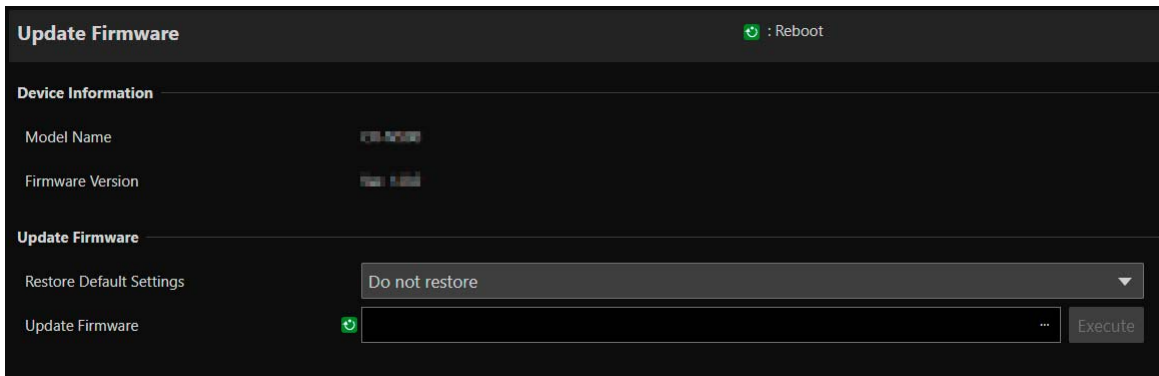

Update Firmware Reboot

Device Information

Model Name: [Model Name]

Firmware Version: [Firmware Version]

Update Firmware

Restore Default Settings: Do not restore

Update Firmware: [File Selection] Execute

Device Information

[Model Name], [Firmware Version]

Displays the camera information.

Update Firmware

Updating the firmware.



Important

Do not turn off the power to the camera while performing [Update Firmware]. Turning off the camera may prevent the camera from operating correctly.

[Restore Default Settings]

Restores the default settings when the firmware is updated.

When set to [Restore], initialization will be performed except for the following settings.

- Network Settings
- NTP Server
- HTTP Server
- Host Access Restrictions
- Time Zone
- Certificates
- SSL/TLS
- Administrator Name
- Administrator Password

[Update Firmware]

Click [...] to select the firmware file for updating and click [Execute]. When a confirmation message is displayed, click [OK] to start Update Firmware. The POWER lamp on the rear of the camera blinks during the update.

After the firmware is updated, the camera will be rebooted.

[System] > [Maintenance] > [Log]

Displaying and downloading log messages.

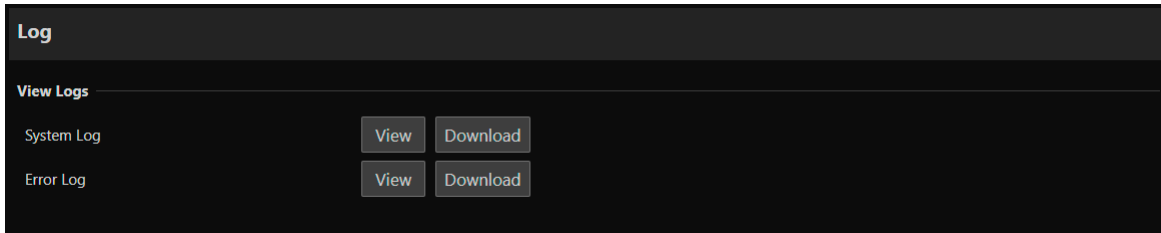

View Logs

Displays the history of camera operation and connection.

[System Log], [Error Log]

When [View] is clicked, displays log messages since the camera was turned on.

When [Download] is clicked, the message list can be downloaded as a file.

For details on log messages, refer to "List of Log Messages" (P. 89).

Chapter 4

Appendix

This chapter explains the measures to take when trouble occurs or a log message is displayed during camera use.

It also explains how to reset the camera to the factory default settings, major specifications and camera security measures.

Troubleshooting

Before contacting the dealer or a Canon sales representative, check the following items. If a log message is displayed, check the details of the message and the corresponding countermeasures in the log message list.

Note

- For information on troubleshooting for the Remote Camera Control Application, the Remote Camera Controller RC-IP100, refer to each manual.
- A problem caused by the security software may occur. Configure to exclude the camera, or the software where the problem occurred, in the security software.

Problem	Countermeasures
The camera does not launch.	<ul style="list-style-type: none"> • If a PoE++ supported hub is being used, check if the LAN cable is connected correctly. • When using a DC power supply, make sure that all cables from the power supply to the camera are connected properly. If it still does not start up, make sure that 12 V DC is supplied correctly. • Turn the camera off and restart (P. 15). • Some PoE++ supported hubs limit the power used per port or the total power consumed by each port. If the limit is exceeded, it may not start, so check the instructions of PoE++ supported hub for use. • Check if there is no blackout at the site.
Settings Page is not displayed.	<ul style="list-style-type: none"> • Check if the LAN cable is connected correctly. • Check if the network to which the camera is connected is set up correctly. In particular, check if the IP address, subnet mask and default gateway address are set within the ranges supported by the applicable network. • If the IP address was changed, the new address will not become effective until the camera is rebooted. • Check if the correct URI (camera IP address) is entered in the web browser. • Check whether the connection is from a computer whose access is blocked in [System] > [Security] > [Host Access Restrictions] (P. 73). • Configure to exclude the camera, or the software where the problem occurred, in the security software.
The camera cannot be operated from the remote controller that supports Standard Communication (Serial).	<ul style="list-style-type: none"> • RS-422 connection is not working correctly. Check the connection to the RS-422 terminal and the wiring of the RS-422 cable. • The settings of serial connection on the remote controller and on the Settings Page are different. Select [System] > [Communication] > [External Connection (Serial)], check [Serial Device Address], and set the camera number to the same as that of the remote controller. Also set Baud Rate (9600 bps or 38400 bps) to the same setting.
Pan/tilt cannot be operated.	<ul style="list-style-type: none"> • External factors such as strong wind and obstacles are considered. Remove the cause of the error, and then retry the operation.
There is no audio during IP distribution.	<ul style="list-style-type: none"> • If there is no audio, check the settings in [System] > [Video and Audio] > [Audio] as well as the sound and audio device settings for the computer. • Audio cannot be heard on the Settings Page.
There is no video or audio on the external monitor during HDMI/SDI output.	<ul style="list-style-type: none"> • The camera is not properly connected to an external monitor. Check the cable connections, and disconnect and connect the cable, or turn the camera off and restart. • Set the external monitor according to the output signal of the camera. • Check if [System] > [Video and Audio] > [Audio] > [Audio Input] is set to [Enable].
The sound is distorted or reduced.	<ul style="list-style-type: none"> • Shooting near loud sounds (fireworks, concerts, etc.) may distort or make the sound smaller than it actually is. In [System] > [Video and Audio] > [Audio] > [General Audio] > [Input Volume], adjust the volume of the input audio.
Forgot the administrator password.	<ul style="list-style-type: none"> • It is possible to initialize all settings of the camera excluding date and time using the RESET switch (P. 96). After performing initialization, use the Camera Search Tool to register the administrator account again. The IP address and subnet mask, etc. also need to be set again because the network settings are initialized.
The tally lamp does not light.	<ul style="list-style-type: none"> • In [System] > [System] > [Camera], set [Tally Lamp Control] to [Enable].

Problem	Countermeasures
The POWER lamp (orange) on the rear of the camera blinks.	<ul style="list-style-type: none"> • The firmware of the camera is being updated. It may take a while. • The pan/tilt position is shifted. Executing [Pan/Tilt Initialization] in [System] > [Maintenance] > [General] > [Tool] initializes the pan/tilt position. • If the POWER lamp (orange) continues to blink after taking any of the above measures, it may be a malfunction with the camera. Restart the camera. If the problem persists, please contact the dealer or a Canon sales representative.
Out of focus.	<ul style="list-style-type: none"> • When autofocus is used to control the focus, some subjects may be difficult to focus on automatically. If this happens, adjust the focus manually. • If the lens protector is dirty, clean it. For details, refer to "Routine Maintenance" (P. 23).
Subject appears bent diagonally.	<ul style="list-style-type: none"> • When shooting a fast-moving subject or when the angle of view changes during shooting, the subject may appear to be bent diagonally. This is a phenomenon that occurs when a CMOS image sensor is used, and is not a camera malfunction.
The image rotates in the opposite direction to the camera operation.	<ul style="list-style-type: none"> • Make sure [System] > [System] > [Camera] > [Installation Conditions] is set to [Video Flip] correctly (P. 75). • If connecting to a remote controller, the setting of the controller may be reverse. For details, refer to the instruction manual of controller.
Files cannot be saved.	<ul style="list-style-type: none"> • Operation System prohibits saving to certain folders. Accordingly, an attempt to save a file may fail. Specify other folders such as [Documents], [Pictures], etc.

List of Log Messages

Log Messages on the Camera

The list of log messages displayed in [System] > [Maintenance] > [Log] > [View Logs] on the Settings Page (P. 85). Log messages are classified into the following types.

Category	Level	Code	Fault level
crit	Error	4xx	Software-level failure (Task operations will stop)
err	Error	3xx	Operational error (Operations will continue)
warning	Warning	2xx	Non-operational error
notice	Warning	1xx	Error outside of the system
info	Information	0xx	Information on normal operation



Note

If no content is recorded in a log for approximately two hours, "--MARK--" will be recorded in the message area.

Error Log

System Error

S303 Error on saving settings [err]

Description	Can't update files of system settings (S303)
Meaning	An error generated while the system was saving a setting. Can't update system settings.
Countermeasure	If the error is detected after rebooting, initialize to the factory default settings. If the problem persists, contact the dealer.

S320 PAN/TILT operation error [err]

Description	%1 error occurred. [%2] (S320)
%1	PAN TILT
%2	Error details
Meaning	An error occurred during operation or stopping of pan/tilt.
Countermeasure	Follow the steps below to take measures. 1. First, check if there is something inhibiting the pan/tilt operation such as the case camera's head unit is in contact with something. Then operate the pan/tilt. 2. Execute [Pan/Tilt Initialization]. 3. Restart the camera. 4. If the problem is not resolved after taking the measures from 1 to 3 above, contact the dealer as there is a possibility of malfunction.

S327 PAN/TILT stop error [err]

Description	(S327)
Meaning	An error occurred with the pan/tilt during rebooting.
Countermeasure	If pan/tilt cannot be operated after rebooting, contact the dealer as there is a possibility of malfunction.

S330 Broken fan [err]

Description	FAN does not rotate. (S330)
Meaning	The fan does not rotate or a significant decrease in speed is detected.
Countermeasure	If the error is still detected after rebooting, it may be a failure with the fan, so contact the dealer.

S332 Fan operation has failed [err]

Description	Cannot control FAN. (S332)
Meaning	IO is not available to control the fan.
Countermeasure	If the error is still detected after rebooting, it may be a failure with the fan, so contact the dealer.

S350 Error in resuming from or switching to standby [err]

Description	Failed to resume from standby or switch to standby (S350)
Meaning	Failed to resume from or switch to the standby status.
Countermeasure	If the error is still detected after rebooting, contact the dealer.

S360 Audio Video synchronize error [err]

Description	Audio Video synchronize error. (S360)
Meaning	Video/Audio synchronize error
Countermeasure	If the error is still detected after rebooting, it may be a failure, so contact the dealer.

S430 Temperature sensor failure [crit]

Description	cannot get temperature (S430)
Meaning	Cannot get the temperature from the temperature sensor.
Countermeasure	If the error is still detected after rebooting, it may be a failure of the board, so contact the dealer.

■ Audio Server Error

B301 Audio device error [err]

Description	cannot use audio device for %1 [%2:%3] (B301)
%1	Send/Receive type (rx tx)
%2	Error type (open write flush)
%3	Error number
Meaning	Detected an error in the audio device.
Countermeasure	If the error is still detected, contact the dealer.

B402 Audio server initialization failed [err]

Description	wv audio initialization error [%1] (B402)
%1	Error number
Meaning	The audio server could not be initialized. The audio server stops.
Countermeasure	If the error is still detected after rebooting, it may be a failure, so contact the dealer.

B403 Settings change failed [err]

Description	cannot set config [%1:%2] (B403)
%1	Error notification number
%2	Error number
Meaning	The settings could not be updated. The audio server stops.
Countermeasure	If the error is still detected after rebooting, it may be a failure, so contact the dealer.

■ Video Error

V400 Video input initialization error [crit]

Description	video %1 initialization failure - %2 (%3) (V400)
%1	Video number
%2	Process description
%3	Error details
Meaning	The video input function was stopped because the video input system could not be initialized.
Countermeasure	If the error is still detected after rebooting, it may be a failure, so contact the dealer.

V401 Video input command error [crit]

Description	video command error - %1 (V401)
%1	Process description
Meaning	The video input function was stopped because a video input command could not be processed. Or, it may not operate in the desired setting.
Countermeasure	If the error is still detected after rebooting, it may be a failure, so contact the dealer.

V402 Video input frozen [crit]

Description	video %1 stalled (V402)
%1	Video number
Meaning	The video input function was stopped because the video input from the camera stopped.
Countermeasure	If the error is still detected after rebooting, it may be a failure, so contact the dealer.

■ Standard Communication (IP) Error

D401 Standard communication (IP) initialization failed [crit]

Description	Standard Com initialization error[%1] (D401)
%1	Error number
Meaning	Standard communication (IP) could not be initialized.
Countermeasure	If the error is still detected after rebooting, it may be a failure, so contact the dealer.

■ RTP Error

R401 RTP initialization failed [crit]

Description	RTP initialization error[%1] (R401)
%1	Error number
Meaning	RTP could not be initialized.
Countermeasure	If the error is still detected after rebooting, it may be a failure, so contact the dealer.

■ NDI|HX Error

P401 NDI|HX initialization failed [crit]

Description	NDI HX initialization error[%1] (P401)
%1	Error number
Meaning	NDI HX could not be initialized.
Countermeasure	If the error is still detected after rebooting, it may be a failure, so contact the dealer.

■ NU Error

N401 NU initialization failed [crit]

Description	NU initialization error[%1] (N401)
%1	Error number
Meaning	NU could not be initialized.
Countermeasure	If the error is still detected after rebooting, it may be a failure, so contact the dealer.

Warning Log

■ Audio Server Warning

B203 Audio message send failure [warning]

Description	audio message send error %1 [%2] (B203)
%1	Message type
%2	Error number
Meaning	Failed to send audio message.

B204 Audio message receive error [warning]

Description	audio message rcv error [%1:%2] (B204)
%1	Error notification number
%2	Reason for error
Meaning	Failed to receive audio message.

■ Camera Application Warning

C211 Camera control command overflow [warning]

Description	command queue overflowed (C211)
Meaning	The camera control command queue overflowed, and some commands were discarded.
Countermeasure	Send the camera control command again after a while.

C221 Preset recall during the washer operation [warning]

Description	Can't run preset, because washer is on. (C221)
Meaning	Preset was recalled during the washer operation.
Countermeasure	Recall the preset after the washer operation stops.

C222 Recall preset during the color bars output [warning]

Description	Can't run preset, because color bars is on. (C222)
Meaning	Preset was recalled during the color bars output.
Countermeasure	Turn off the color bars output and recall the preset again.

C231 Trace execution during the washer operation [warning]

Description	Can't run trace, because washer is on. (C231)
Meaning	Tracing was executed during the washer operation.
Countermeasure	Wait until the washer operation stops, then try executing trace again.

C232 Trace execution during the color bars output [warning]

Description	Can't run trace, because color bars is on. (C232)
Meaning	Tracing was executed during the color bars output.
Countermeasure	Turn off color bars output and try tracing again.

RTP Warning

R101 RTSP authentication failure [notice]

Description	RTSP Error: error_code=401: Unauthorized (R101)
Meaning	RTSP authentication failed.

R102 RTSP connection failure [notice]

Description	RTSP Error: error_code=%d: (R102)
%d	400: When an invalid RTSP request is received etc. 503: The maximum number of RTP connections has been exceeded, or a request for multiple session streaming with tunneling for the same stream has been received, etc.
Meaning	RTSP connection has failed.

R103 RTP session disconnected [notice]

Description	session closed: num_of_sessions=%1 (R103)
%1	Total number of sessions for clients
Meaning	The session was disconnected from the client due to a factor other than TEARDOWN. (For example, TCP FIN)

R104 RTP session deleted [notice]

Description	session removed: num_of_sessions=%1 (R104)
%1	Total number of sessions for clients
Meaning	The session was deleted due to errors. (Session Timeout or when an invalid RTSP request is received)

Notification Log

System Notification

S001 System started [info]

Description	starting paramd (S001)
Meaning	Parameter management module started.

S002 System settings changed [info]

Description	Updated system settings. (S002)
Meaning	Settings which do not require rebooting were changed.

S050 IPv4 address assigned to wired LAN interface [info]

Description	IPv4 Address %1 %2 was assigned to the wired I/F (S050)
%1	Set IPv4 address
%2	from router for DHCPv4 address
Meaning	IPv4 address is set for wired LAN.

S051 IPv6 address assigned to wired LAN interface [info]

Description	IPv6 Address %1 %2 was assigned to the wired I/F (S051)
%1	Set IPv6 address
%2	from router for DHCPv6/RA address
Meaning	IPv6 address is set for wired LAN.

S054 IPv4 address for wired LAN interface is released [info]

Description	IPv4 Address %1 %2 was released from the wired I/F (S054)
%1	Released IPv4 address
%2	from router for DHCPv4 address
Meaning	IPv4 address assigned to wired LAN is released.

S055 IPv6 address for wired LAN interface is released [info]

Description	IPv6 Address %1 %2 was released from the wired I/F (S055)
%1	Released IPv6 address
%2	from router for DHCPv6/RA address
Meaning	IPv6 address assigned to wired LAN is released.

S070 Change to certificate [info]

Description	%1: succeeded to %2 certificate (S070)
%1	ssl
%2	generate import delete export
Meaning	A certificate was created/imported/deleted/exported.

S080 The power required to start the camera system is not supplied [info]

Description	Insufficient power to boot the camera system. (S080)
Meaning	The power required to start the camera system is not being supplied.
Countermeasure	Use a DC or PoE++ supported L2 switch as the power source.

■ HTTP Server Notification

H001 System started/stopped [info]

Description	%1 httpd (H001)
%1	starting stopping
Meaning	HTTP Server started/stopped.

H145 Authentication failure [notice]

Description	Authentication failed for %1, IP: %2 (H145)
%1	Implemented countermeasures against URL XSS vulnerability (Equivalent to ftpd)
%2	IP address
Meaning	Authentication failed.

■ wvhttp Notification

W001 System started/stopped [info]

Description	%1 wvhttp (W001)
%1	starting stopping
Meaning	wvhttp server started/stopped.

W030 Startup and shutdown of wvhttp client [info]

Description	%1%2 host=<Host>, user=<User>, prio=<Priority> (W030)
%1	W (wvhttp session) V (Session-less video client) N (Session-less event client)
%2	+: Connect, -: Disconnect
Meaning	The camera server client was connected or disconnected.

W031 Transmitted video data size [info]

Description	%1= host=<Host>, user=<User>, video=<Number of frames> (W031)
%1	W (wvhttp session) V (Session-less video client)
Meaning	When a client disconnected, the total data that was sent to the client is displayed in number of frames.

W103 Authentication failure [notice]

Description	Authentication failed, IP: <IP address> (W103)
Meaning	Authentication failed.

■ Audio Server Notification

B001 Audio server started/stopped [info]

Description	%1 audio. (B001)
%1	starting stopping
Meaning	The audio server started/stopped.

B101 Received unusual request [notice]

Description	%1 unusual request[%2] (B101)
%1	Client host IP address
%2	Unusual type (400 404)
Meaning	Refused the request due to command error (400) and parameter error (404).

■ Camera Application Notification

C001 Camera control module started/stopped [info]

Description	%1 camerad (C001)
%1	starting stopping
Meaning	The camera control module started/stopped.

C002 Camera application started/stopped [info]

Description	starting cameraappl (C002)
Meaning	The camera application started.

■ Video Notification

V001 Video server started/stopped [info]

Description	%1 video (V001)
%1	starting stopping
Meaning	The video server started/stopped.

■ Standard Communication (IP) Notification

D001 Standard communication (IP) notification started/stopped [info]

Description	%1 Standard Com (D001)
%1	starting stopping
Meaning	The standard communication (IP) started/stopped.

■ RTP Notification

R001 RTP started/stopped [info]

Description	%1 RTP (R001)
%1	starting stopping
Meaning	The RTP started/stopped.

R002 RTSP PLAY request received [info]

Description	PLAY received: client_IP=%1, num_of_sessions=%2 (R002)
%1	Client IP address <ul style="list-style-type: none"> Displays "HTTP tunneling connection" if the streaming protocol is HTTP tunneling.
%2	Total number of sessions for clients
Meaning	RTSP PLAY request was received.

R003 RTSP TEARDOWN request received [info]

Description	TEARDOWN received: client_IP=%1, num_of_sessions=%2 (R003)
%1	Client IP address <ul style="list-style-type: none"> Displays "HTTP tunneling connection" if the streaming protocol is HTTP tunneling.
%2	Total number of sessions for clients
Meaning	RTSP TEARDOWN request was received.

■ NDI|HX Notification

P001 NDI|HX started/stopped [info]

Description	%1 NDI HX (P001)
%1	starting stopping
Meaning	The NDI HX started/stopped.

■ NU Notification

N001 NU started/stopped [info]

Description	%1 NU (N001)
%1	starting stopping
Meaning	The NU started/stopped.

Restoring to the Factory Default Settings

If the settings have been forgotten and want to set the camera from the beginning, restore to the factory default settings. It is recommended to use [System] > [Maintenance] > [Backup/Restore] on the Settings Page to create a backup file before restoring the factory default settings (P. 83).

Important

If restored to the factory default settings, the camera will be unable to connect because the administrator account is also initialized. Use the Camera Search Tool to configure the default settings.

Note

For the factory default settings, refer to P. 97.

Restoring to the Initial Settings from a Web Browser

Use [System] > [Maintenance] > [General] > [Initialization] > [Network Settings and Management Information] > [Do not save] on the Settings Page (P. 81).

Restoring to the Factory Default Settings with the RESET Switch on the Camera

If the IP address or the Administrator password on the camera is forgotten, operating the camera via the network is not possible. In this case, press the RESET switch located in the camera's receptacle unit (P. 13) to initialize the camera.

1 Turn the camera off.

The camera does not have a power switch. In order to turn the camera on or off, connect or disconnect the power supply cable.

2 Turn on the power while pushing the RESET switch, confirm that the POWER lamp lights up (green), and then release the RESET switch after about five seconds.

The RESET switch is located in a recessed area. Push the switch using the tip of a pointed object such as a clip. When the POWER lamp stops blinking (green), the reset procedure is complete.

List of Factory Default Settings

Item	Factory default settings
<ul style="list-style-type: none"> Exposure 	
Shooting Mode	Full Auto
Infrared	Off
Enhanced ND Filter	Off
Iris Limit	On
Flicker Reduction	Off
Auto Slow Shutter	On
<ul style="list-style-type: none"> WB/Color 	
White Balance:R Gain	0
White Balance:B Gain	0
Color Matrix:Gain	0
Color Matrix:R-G	0
Color Matrix:R-B	0
Color Matrix:G-R	0
Color Matrix:Phase	0
Color Matrix:G-B	0
Color Matrix:B-R	0
Color Matrix:B-G	0
<ul style="list-style-type: none"> Image Quality 	
Gamma	Normal1 (Standard)
Color Space	BT.709 Gamut
Color Matrix	Video
<ul style="list-style-type: none"> Image Quality Details 	
Sharpness:Level	0
Sharpness:Limit	0
Noise Reduction	Auto
Black:Master Pedestal	0
Black:Master Black Red	0
Black:Master Black Blue	0
Black Gamma:Level	0
Black Gamma:Range	0
Black Gamma:Point	0
Knee:Activate	On
Knee:Automatic	On
Knee:Saturation	0
<ul style="list-style-type: none"> Focus 	
Focus Mode	AF
Face Detection AF	Face Det. & Tracking
AF Speed	Normal

Item	Factory default settings
AF Response	Normal
Focus Limit	Off
<ul style="list-style-type: none"> PTZ/IS 	
Digital Zoom	Off
Soft Zoom Control	Off
Pan/Tilt Acceleration	Medium
Image Stabilizer	Standard
<ul style="list-style-type: none"> Other Functions 	
Color Bars	Off
AUX OUT	Off
AUX IN	-

System

Item	Factory default settings
<ul style="list-style-type: none"> HDMI/SDI 	
Video Output Configuration	1920x1080/59.94P
<ul style="list-style-type: none"> SDI 	
3G-SDI Mapping	Level A
<ul style="list-style-type: none"> Mainstream 	
Video Codec	H.264
Video Size	1920x1080
Framerate (fps)	59.94
Bit Rate Control	VBR
Target Bit Rate (Mbps)	20
I Frame Interval (sec.)	1.0
<ul style="list-style-type: none"> Substream 1 	
Video Codec	H.264
Video Size	640x360
Framerate (fps)	29.97
Bit Rate Control	VBR
Target Bit Rate (Mbps)	6
I Frame Interval (sec.)	1.0
<ul style="list-style-type: none"> Substream 2 	
Video Codec	JPEG
Video Size	1280x720
Framerate (fps)	14.99
<ul style="list-style-type: none"> General Audio 	
Audio Input	Disable

Item	Factory default settings
<ul style="list-style-type: none"> • HTTP Server <ul style="list-style-type: none"> Authentication Method HTTP Port HTTPS Port • Video Server <ul style="list-style-type: none"> Maximum Number of Clients Maximum Connection Time (sec.) 	<ul style="list-style-type: none"> Digest Authentication 80 443 15 0
<ul style="list-style-type: none"> • RTP Server <ul style="list-style-type: none"> RTP RTSP Authentication Method RTSP Port • Audio Settings <ul style="list-style-type: none"> Audio Compression Method Multicast Address Multicast Port Multicast TTL • RTP Mainstream <ul style="list-style-type: none"> Video Type Multicast Address Multicast Port Multicast TTL Audio Transmission • RTP Substream 1 <ul style="list-style-type: none"> Video Type Multicast Address Multicast Port Multicast TTL Audio Transmission • RTP Substream 2 <ul style="list-style-type: none"> Video Type Multicast Address Multicast Port Multicast TTL Audio Transmission 	<ul style="list-style-type: none"> Enable Digest Authentication 554 AAC-LC 48kHz 0.0.0.0 0 1 H.264 1920x1080 0.0.0.0 0 1 Disable H.264 640x360 0.0.0.0 0 1 Disable JPEG 1280x720 0.0.0.0 0 1 Disable
<ul style="list-style-type: none"> • LAN <ul style="list-style-type: none"> Maximum Packet Size • IPv4 <ul style="list-style-type: none"> IPv4 Address Settings Method AutoIP IPv4 Address (AutoIP) 	<ul style="list-style-type: none"> 1500 Auto (DHCP) Enable -

Item	Factory default settings
<ul style="list-style-type: none"> • IPv6 <ul style="list-style-type: none"> IPv6 Auto (RA) Auto (DHCPv6) IPv6 Address (Manual) Prefix Length IPv6 Default Gateway Address IPv6 Address (Auto) • DNS <ul style="list-style-type: none"> Name Server Address 1 Name Server Address 2 Set Name Server Address Automatically Host Name Search Domain Search Domain List • mDNS <ul style="list-style-type: none"> mDNS 	<ul style="list-style-type: none"> Enable Enable Enable (Blank) 64 (Blank) - (Blank) (Blank) (Blank) (Blank) (Blank) Enable
<ul style="list-style-type: none"> • Standard Communication (IP) <ul style="list-style-type: none"> Standard Communication (IP) Response Port Number Camera IP Settings Inquiry Camera IP Settings Network Settings • NDI HX <ul style="list-style-type: none"> NDI HX • RTMP <ul style="list-style-type: none"> RTMP 	<ul style="list-style-type: none"> Enable Specified Port Number (52381) Allow Do Not Allow Disable Disable
<ul style="list-style-type: none"> • Serial Port <ul style="list-style-type: none"> Protocol Serial Port Connection Type Data Length (bit) Start Bit (bit) Stop Bit (bit) Parity 	<ul style="list-style-type: none"> NU RS422 8 1 1 None
<ul style="list-style-type: none"> • Server Certificate Management <ul style="list-style-type: none"> Server Certificates Server Certificate Password Server Certificate List • Create Certificate <ul style="list-style-type: none"> Country (C) State/Province (ST) 	<ul style="list-style-type: none"> (Blank) (Blank) (Blank) (Blank) (Blank)

Item	Factory default settings
Locality (L)	(Blank)
Organization (O)	(Blank)
Organizational Unit (OU)	(Blank)
Common Name (CN)	(Blank)
Validity Period Start Date	(Blank)
Validity Period End Date	(Blank)
<ul style="list-style-type: none"> Encrypted Communications HTTPS Connection Policy	HTTP and HTTPS
<ul style="list-style-type: none"> Server Certificates Server Certificates	(Blank)
<ul style="list-style-type: none"> Administrator Account Administrator Name	(Blank)
<ul style="list-style-type: none"> Administrator Account Password	(Blank)
<ul style="list-style-type: none"> Administrator Account Confirm Password	(Blank)
<ul style="list-style-type: none"> Authorized User Account User Name	(Blank)
<ul style="list-style-type: none"> Authorized User Account Password	(Blank)
<ul style="list-style-type: none"> Authorized User Account Confirm Password	(Blank)
<ul style="list-style-type: none"> Authorized User Account User List	(Blank)
<ul style="list-style-type: none"> User Authority Authorized User	Camera Control <input checked="" type="checkbox"/>
	Video Distribution <input checked="" type="checkbox"/>
<ul style="list-style-type: none"> User Authority Guest User	Camera Control <input checked="" type="checkbox"/>
	Video Distribution <input checked="" type="checkbox"/>
<ul style="list-style-type: none"> IPv4 Host Access Restrictions Apply Host Access Restrictions	Disable
<ul style="list-style-type: none"> IPv6 Host Access Restrictions Apply Host Access Restrictions	Disable
<ul style="list-style-type: none"> Camera Name Camera Name	Camera
<ul style="list-style-type: none"> Installation Conditions Video Flip	Disable
<ul style="list-style-type: none"> Camera Control Auto Flip	Enable
<ul style="list-style-type: none"> Color Bars Color Bar Type	SMPTE
<ul style="list-style-type: none"> AUX OUT Operation Mode	Normally Open
<ul style="list-style-type: none"> Tally Lamp Tally Lamp Control	Enable
<ul style="list-style-type: none"> Tally Lamp Tally Lamp Brightness	Medium

Item	Factory default settings
<ul style="list-style-type: none"> Genlock Genlock	Disable
<ul style="list-style-type: none"> Current Date and Time Settings	Set manually
<ul style="list-style-type: none"> Settings Settings Method	(GMT+09:00) Osaka, Sapporo, Tokyo
<ul style="list-style-type: none"> Settings Time Zone	(GMT+09:00) Osaka, Sapporo, Tokyo
<ul style="list-style-type: none"> Settings Daylight Saving Time	Disable
<ul style="list-style-type: none"> Environment Frame Frequency (Hz)	59.94
<ul style="list-style-type: none"> Initialization Network Settings and Management Information	Save
<ul style="list-style-type: none"> Backup/Restore Restore Settings	(Blank)
<ul style="list-style-type: none"> Backup/Restore Encryption Password	(Blank)
<ul style="list-style-type: none"> Update Firmware Restore Default Settings	Do not restore

Specifications

For the latest information on this product (firmware and software, user manuals, operating environment, etc.), refer to the Canon website.

CR-X300 Main Unit

■ Camera

Image Sensor	Type 1/2.3 (1/2.3 in.) single-plate CMOS sensor Total pixels: approx. 21.14 megapixels Effective pixels: approx. 8.29 megapixels (3840 x 2160)	
Lens	f=3.67 – 73.4 mm, F/1.8 – 2.8, 20x optical zoom 35mm equivalent focal length: [4K UHD] approx. 29.3 (W) – 601 mm (T) [Full HD] approx. 30.5 (W) – 627 mm (T) 8-bladed circular aperture 12 elements in 10 groups (including 2 aspheric elements)	
Digital Zoom	20x	
Minimum Focusing Distance	1 cm (0.39 in.) at maximum wide angle, 60 cm (2.0 ft.) throughout the zoom range (from the lens protector)	
Angle of View	[4K UHD] Horizontal: 65.6° (W) – 3.6° (T) Vertical: 39.8° (W) – 2.0° (T) [Full HD] Horizontal: 63.5° (W) – 3.4° (T) Vertical: 38.4° (W) – 1.9° (T)	
Shutter Speed	1/6 – 1/2000 sec. (specific values depend on the frame frequency)	
Focus	Focus mode: Manual, Continuous AF, Face Detection AF, Tracking AF type: Hybrid AF, Contrast AF	
Shooting Mode	F.Auto, P, Tv, Av, M	
	Scene Mode	Portrait, Sports, Low light, Spotlight
Custom Picture	Gamma	Normal1, Normal3
	Color Space	BT.709, BT.2020
	Color Matrix	Neutral, Video
ND Filter	ND filter: 1/8 at maximum Enhanced ND filter: 1/32	
IR Mode	Electrically switchable	
Image Stabilizer	Optical-shift (Standard IS, Powered IS)	
White Balance	AUTO (AWB), Set A, Set B, preset settings (daylight: approx. 5600 K*, tungsten lamp: approx. 3200 K*), color temperature setting (2000 K – 15000 K), Manual * Color temperatures are given for reference purposes only.	
Gain	0.0 – 36.0 dB	
Min. Subject Illumination	Approx. 3.0 lux (shutter speed 1/60 sec., frame frequency 59.94 Hz (P (Program AE) shooting mode), auto slow shutter "Off")	
Video Flip	Supports upright/ceiling installation, flip function ("Auto Flip" enabled/disabled)	
Built-in Microphone	Waterproof microphone	

■ Server

Video Output Signal	SDI	<p>3840 x 2160: 29.97P, 25.00P, 23.98P (4:2:2 10 bit) 1920 x 1080: 59.94P/59.94i, 50.00P/50.00i/25.00P, 29.97P/23.98P (4:2:2 10 bit) 1280 x 720: 59.94P, 50.00P (4:2:2 10 bit)</p> <ul style="list-style-type: none"> – Same video format required for SDI and HDMI (cannot select different formats for SDI and HDMI) – When 3840 x 2160 is selected for SDI, video will not be outputted to HDMI.
	HDMI	<p>3840 x 2160: 29.97P, 25.00P, 23.98P (4:2:2 10 bit) 1920 x 1080: 59.94P/59.94i, 50.00P/50.00i/25.00P, 29.97P/23.98P (4:2:2 10 bit) 1280 x 720: 59.94P, 50.00P (4:2:2 10 bit)</p> <ul style="list-style-type: none"> – Same video format required for SDI and HDMI (cannot select different formats for SDI and HDMI) – When 3840 x 2160 is selected for HDMI, video will not be outputted to SDI.
	IP	<p>Frame Frequency 59.94 Hz 1920 x 1080: 59.94 fps, 29.97 fps, 14.99 fps, 5.00 fps (4:2:0 8 bit) 1280 x 720: 59.94 fps, 29.97 fps, 14.99 fps, 5.00 fps (4:2:0 8 bit) 640 x 360: 59.94 fps, 29.97 fps, 14.99 fps, 5.00 fps (4:2:0 8 bit)</p> <p>Frame Frequency 29.97 Hz 3840 x 2160: 29.97 fps, 14.99 fps, 5.00 fps (4:2:0 8 bit) 1920 x 1080: 29.97 fps, 14.99 fps, 5.00 fps (4:2:0 8 bit) 1280 x 720: 29.97 fps, 14.99 fps, 5.00 fps (4:2:0 8 bit) 640 x 360: 29.97 fps, 14.99 fps, 5.00 fps (4:2:0 8 bit)</p> <p>Frame Frequency 50.00 Hz 1920 x 1080: 50.00 fps, 25.00 fps, 12.50 fps, 5.00 fps (4:2:0 8 bit) 1280 x 720: 50.00 fps, 25.00 fps, 12.50 fps, 5.00 fps (4:2:0 8 bit) 640 x 360: 50.00 fps, 25.00 fps, 12.50 fps, 5.00 fps (4:2:0 8 bit)</p> <p>Frame Frequency 25.00 Hz 3840 x 2160: 25.00 fps, 12.50 fps, 5.00 fps (4:2:0 8 bit) 1920 x 1080: 25.00 fps, 12.50 fps, 5.00 fps (4:2:0 8 bit) 1280 x 720: 25.00 fps, 12.50 fps, 5.00 fps (4:2:0 8 bit) 640 x 360: 25.00 fps, 12.50 fps, 5.00 fps (4:2:0 8 bit)</p> <p>Frame Frequency 23.98 Hz 3840 x 2160: 23.98 fps, 11.99 fps, 5.99 fps (4:2:0 8 bit) 1920 x 1080: 23.98 fps, 11.99 fps, 5.99 fps (4:2:0 8 bit) 1280 x 720: 23.98 fps, 11.99 fps, 5.99 fps (4:2:0 8 bit) 640 x 360: 23.98 fps, 11.99 fps, 5.99 fps (4:2:0 8 bit)</p> <ul style="list-style-type: none"> – JPEG has one pattern fixed depending on the frame frequency (format is fixed and cannot be selected) Resolution: 1280 x 720 When frame frequency is 59.94/29.97 Hz: 14.99 fps When frame frequency is 50.00/25.00 Hz: 12.50 fps When frame frequency is 23.98 Hz: 11.99 fps
Video Transmission Protocol	XC (Canon's original), RTSP/RTP, NDI HX, RTMP/RTMPS	
Control Protocol	XC (Canon's original), NU (Canon's original), NDI HX, Standard Communication (Serial), Standard Communication (IP)	
Preset	Number of presets: Max. 100 (including home position)	

■ Interface

Communication Control	LAN, Serial
Network Terminal	LAN x 1, RJ45, 1000Base-T
6G-SDI OUT Terminal	BNC jack (output only) x 1, 0.8 Vp-p/75 Ω, unbalanced SMPTE 2081, 424, 425, ST 299-2 compliant Embedded audio, Time code (VITC/LTC)
GEN-LOCK Terminal	BNC jack x 1, 1.0 Vp-p/75 Ω, input only
HDMI OUT Terminal	HDMI connector x 1, output only
RS-422 Terminal	RJ45 connector x 1
External Device I/O Terminal	AUX connector x 1

■ Pan/Tilt Section

Pan-Tilt Head Operations	Operation Range	Pan operation range: Horizontal $\pm 180^\circ$ Tilt operation range: Vertical $-40^\circ - +215^\circ$
	Operation Speed	0.3° – 60°/sec.
	Position Accuracy	within $\pm 10'$
	Noise	NC45 or lower (when operating at 60°/sec.)
	Wiper	Equipped

■ Others

Operating Environment	Temperature/Humidity Resistance	$-15^\circ\text{C} - +40^\circ\text{C}$ ($+5^\circ\text{F} - +104^\circ\text{F}$), Humidity 90% or less (without condensation) (Startup temperature $-10^\circ\text{C} - +40^\circ\text{C}$ ($+14^\circ\text{F} - +104^\circ\text{F}$))
	Survival Wind Speed	15 m/sec.: Normal operation 30 m/sec.: Operation possible 60 m/sec.: Non destruction
Installation Method	Supports upright/ceiling installation	
Power Supply	PoE: PoE++ power supply via LAN connector (IEEE802.3bt compliant) – PoE and PoE+ cannot be used External power source: 12 V DC (Use the included power cable with DC plug)	
Power Consumption	PoE++ Input: Approx. 39.8 W* max. (body only) DC Input: Approx. 37.7 W max. (body only) * Class 5 (40.0 W required) for power supply devices	
Dimensions (W x H x D)	Approx. 217 x 311 x 217 mm (8.54 x 12.24 x 8.54 in.) (excluding protrusions and connector cover)	
Weight	Approx. 7 kg (15.5 lb.) (body only)	
Dust-resistant/Waterproof	IP65	
Supported Controllers	Hardware: RC-IP100 Software: Remote Camera Control Application	

Operating Environment

■ Settings Page (Computer Environment)

OS	Windows 10 64-bit	macOS 11
CPU	Intel Core i7-4700 or greater	
Memory	8 GB or more	
Web Browser	Microsoft Edge (Chromium) Chrome 92	Safari
Display	Resolution 1920 x 1080 or greater	

- Must be configured to allow use of JavaScript, and web storage
- Only JPEG format is supported for displaying video
- Does not support audio

■ Settings Page (Verified Mobile Environment)

- As of June 2021

OS	iOS 14.7, iPadOS 14.7	Android 11, Android 10
Web Browser	Safari	Chrome 92

- Must be configured to allow use of JavaScript, and web storage
- Only JPEG format is supported for displaying video
- Does not support audio

Appearance

Without Connector Cover

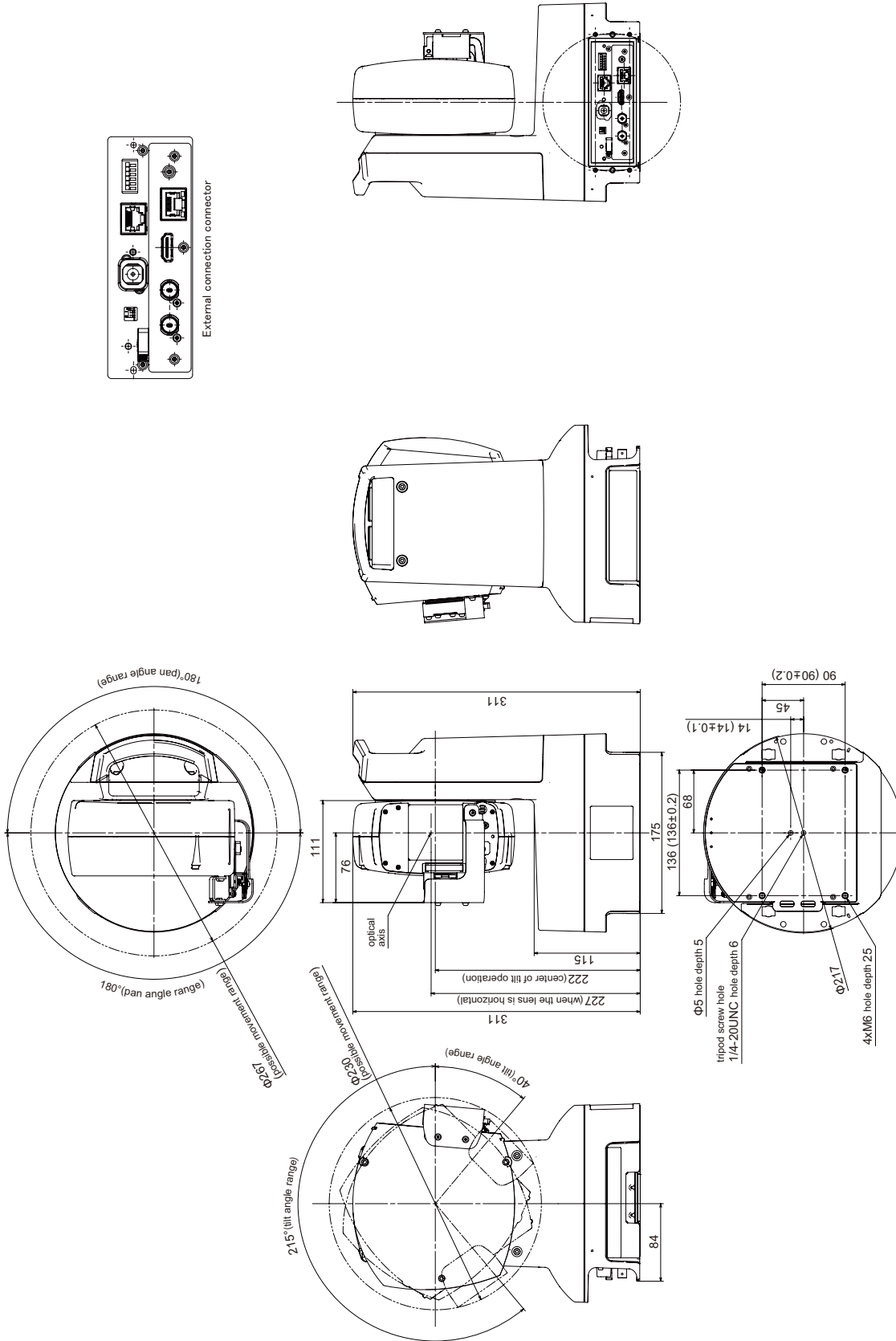

Unit : mm

■ With Connector Cover

Unit: mm

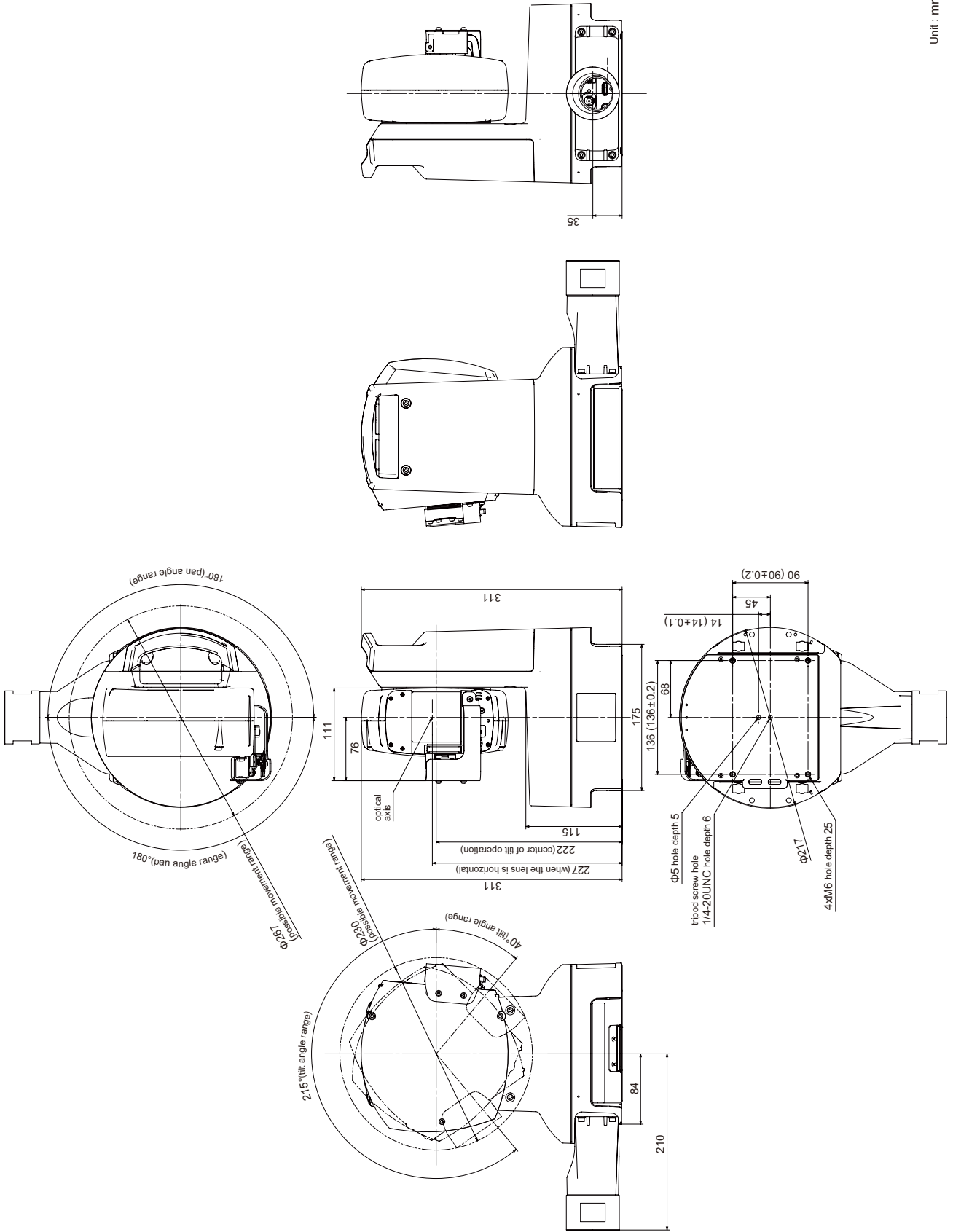

Security Measures

If the camera is connected to a network and used, it may become a target of cyber attacks such as unauthorized access from unintended third parties. Since this camera has a variety of server functions built in, although they can be convenient, there is a risk of being attacked by a third party unless operated with security measures. To completely eliminate all risks is impossible, however, by studying various risk angles and taking measures based on the security policies, it is possible to decrease the risk of cyber attacks.

This section explains the security hardening measures to the camera settings. Refer to this section and implement necessary measures according to the environment under the customer's responsibility, which will lead to safer camera operation. System administrators are advised to read.

Important

To the full extent permitted by laws and regulations, neither Canon Inc. nor any of its subsidiaries or affiliates shall be liable for any losses, direct, incidental or consequential damages, or liabilities that may be incurred as a result of network security incidents such as unauthorized accesses.

The security hardening measures explained in this section are mainly for the cameras, which are a part of an entire system as shown in the figure below. For the entire system's security hardening, measures must be taken according to the customer's network environment and/or purpose of the camera use.

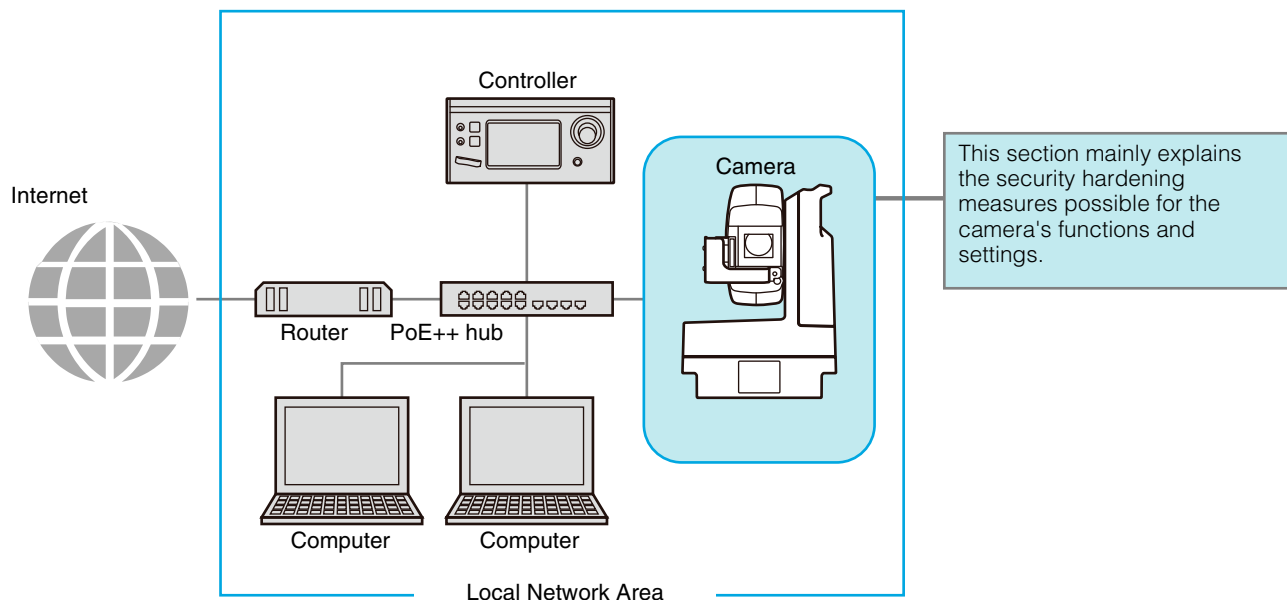

In order to reduce the security risk, it is effective to block access physically and/or virtually if it is unnecessary to be made accessible from an external network, such as the internet.

When access from a remote location is unnecessary and the devices accessing the camera can be limited, using only specific devices in the same local area network will enhance security. When it is necessary to access the camera from a remote location, it is important to use a method that can communicate safely, such as using a VPN (Virtual Private Network) that can block access from the outside.

Basic Measure 1: Setting Administrator Name and Password

The administrator account has authority over all of the camera's settings and operations. If the administrator account is illegally used by an unauthorized party and tampering is done, there is a risk the camera will not be accessible. In order to prevent spoofing of the administrator account, the most fundamental measure for safe operation of the camera is to make the administrator name and password in an array of letters that are difficult to guess by unauthorized users. Strictly manage the administrator account and refrain from settings such as the same administrator account on multiple cameras. The administrator account needs to be set when the camera is started for the first time. After setting, editing can be done on the camera's Settings Page (P. 72).

■ Setting a Strong Administrator Name and Password

In order to strengthen the administrator name and password, consider the following points:

- Combine at least 10 characters of alphanumeric characters or symbols and special characters permitted for the camera.
- Combine upper and lower case characters.
- Avoid commonly used words and string of characters that are easy to guess.

■ Other Passwords

For the camera, in addition to the administrator account, the password for Server Certificate (P. 69), Authorized User (P. 72), and Encrypting Backup Information (P. 83) are to be set. Set these passwords in an array of letters that are difficult to guess by unauthorized parties and manage them appropriately.

Basic Measure 2: Using the Latest Firmware

The camera's firmware is updated as needed in order to improve performance of the functions and bug fixes. From the security point of view, it is important to always keep it updated because the measures against known vulnerabilities are applied to the latest firmware.

Check Canon's website regularly at the initial setting after purchasing the camera and during its operation, whether the latest firmware is provided.

The firmware version can be confirmed and updated on the camera's Settings Page (P. 81, P. 84).

Basic Measure 3: Setting Date and Time

Set the correct date and time for the camera. It is recommended to set the time to an NTP server if connected to the Internet. If there are indications that suspicious unauthorized access occurred, it may be possible to confirm the date and time of occurrence by checking the log.

Date and time is set on the camera's Settings Page (P. 77).

Basic Measure 4: Monitoring the Log

Camera connection status and operating conditions are recorded and saved as a log in the camera embedded memory. Check the logs periodically to quickly find any signs of suspicious unauthorized access, such as repeated user authentication failures. For details on the log, refer to "List of Log Messages" (P. 89).

The logs will be deleted if any of the following operations are performed: rebooting, initialization, and restoring to the factory default settings.

The log will also be deleted if exceeding a certain size.

The log saved in the camera embedded memory can be confirmed on the camera's Settings Page (P. 85).

Measures Suitable to the Users' Environment 1: User Management

"Administrator", "authorized user", and "guest user" are the three types of accounts that are able to access the camera. The administrator account has authority over all of the camera's settings and operations. Administrator is the only account which is able to access the Settings Page. Therefore, in order to prevent leaks to unauthorized users, it is important to strictly manage information on the administrator account.

The "authorized user" and "guest user" are able to access the camera from such as controllers. Understand what the "authorized user" and "guest user" are able to do, and set the minimum necessary authorization level and users.

Authorized Users Means Users Who Require Authentication

To allow only specific users, except the administrator, to control the camera and deliver the video, set up an authorized user. In the authorized user settings, register account information (user name and password) and grant privileges (allow video distribution only, allow camera control, etc.). The same authority is given to all authorized users, therefore it is necessary to be careful to give authority to authorized users. Regularly review and manage the authorized users, and set the minimum necessary authorization level and users.

It is important to disable all the authorities of the guest users, which is described later, when wanting to restrict access to only authorized users. Unless these are disabled, access from the guest users will not be restricted.

Guest Users

Guest user means a guest account which does not need a user name and password. By enabling authorities for the guest users, anyone will be able to access the camera without requiring user authentication. Also, this would allow camera control and video distribution commands without authentication. Therefore, guest users authority should be set only when security is ensured, for example, if used within the network that prohibits the external access, etc., otherwise disable all authority of the guest users.

When allowing access by guest users, grant only the minimum necessary privileges to them, since the same privileges are given to all guest users, just as to all the authorized users.

User management is set on the camera's Settings Page (P. 71).

Measures Suitable to the Users' Environment 2: Host Access Restrictions

By specifying the hosts that can access the camera, the risk of unauthorized access can be reduced.

In order to restrict hosts to access the camera, allow communication with only specified hosts, and prohibit all other communication. Oppositely, there is also the method of prohibiting communication with specified hosts and allowing communication with all others.

Depending on the user's environment, the range of access restriction can be grouped on a network basis, or it can be set for each host. However, if mistakenly setting the administrator's IP address to prohibit communication, access from the administrator to the camera will be prohibited and there will be no other way than to restore to the factory default settings. Caution is needed when setting the access restrictions.

Host access restrictions are set on the camera's Settings Page (P. 73).

Measures Suitable to the Users' Environment 3: Setting to the Digest Authentication

When accessing the cameras via [HTTP Server] and [RTP Server], select [Digest Authentication] for the authentication method. When [Basic Authentication] is selected, the password can be easily leaked to unauthorized parties because the password will be sent on the network without being encrypted.

It is necessary to set the authentication method of the HTTP Server and the RTP Server respectively. Authentication method is set on the camera's Settings Page respectively (P. 59, P. 60). Confirm that the application supports the Digest Authentication.

Measures Suitable to the Users' Environment 4: Changing the Port Number

It is important to limit unspecified access to prevent unauthorized access to the camera. The port number is an entrance to the communication between the camera and the external device, and a number is set for each communication protocol. A common number is used for the port number and network devices can be connected easily. Thus, there is a risk of it being used for intrusion by unauthorized parties.

In case there is a need to change the port number due to concern of security, make sure that the port numbers are not redundant with those of other communication protocols, and set it within the specified range. If the port number is changed, specify the port number in addition to the IP address in order to access the camera.

Example: Changing the Port Number

When connecting by the HTTPS, set "https://{Camera's IP address}:{Port Number}".

When the HTTPS port number is changed to 10443

https://192.168.100.1:10443

HTTP Port Numbers/HTTPS Port Numbers

HTTP/HTTPS port number is set on the camera's Settings Page (P. 59).

It is also possible to change the following port numbers:

- RTSP Port (P. 60)
- Multicast Port (P. 60)

Measures Suitable to the Users' Environment 5: Encrypting Communication

In order to securely communicate between the camera and the external device, it is recommended that all communication be via HTTPS connection (encrypted communication combining SSL/TLS and HTTP). SSL (Secure Sockets Layer)/TLS (Transport Layer Security) is a technology to encrypt communication on the network and prevent hacking and tampering of communication contents by an unauthorized party. Even if the data is hacked during communication, by encrypting the communication in the proper way, the contents of the data are protected and safety can be secured.

Self-Signed Certificate and Server Certificate

To encrypt communication via HTTPS connection, use a self-signed certificate or a server certificate issued from a CA (Certificate Authority). Self-signed certificates are sufficient to do encryption, however, a warning screen will be displayed in the web browser, and there is a risk of impersonation. Therefore, it is advised to use it in the cases for an operation test and others.

It is recommended to acquire and install a server certificate issued from CA for a full-scale system operation.

Encrypting communications by HTTPS connection is set on the camera's Settings Page (P. 70).



Note

Even setting the HTTPS connection as mentioned above, the video distributed via RTP/RTSP cannot be encrypted. In order to securely communicate the video to distribute, it is necessary to deal with the whole system.

Measures Suitable to the Users' Environment 6: Disabling Unused Functions

The camera has functions to support various purposes and network environments. However, unless those functions are properly set, there is a risk of unauthorized access from outside parties. In order to use the camera safely, it is also necessary to disable the setting of unused functions.

The following describes the functions that need to be addressed in the operating environment and usage situation, such as enabling only the necessary functions or disabling the functions after the setting is completed.

AutoIP

When [AutoIP] (P. 63) is enabled, even in environments where there is no DHCP server, IPv4 link-local addresses (169.254.xxx.xxx) are assigned to the camera. Therefore, by assigning a computer to the same network as the IPv4 address and using the Camera Search Tool, the camera can be detected and initial settings can be made.

Although [AutoIP] is enabled by factory default settings, it is recommended to disable [AutoIP] when the initial setting of the network is completed so that it will not be used for unauthorized purposes.

mDNS (multicast Domain Name System)

[mDNS] (P. 64) is a function to notify devices on the network of the camera IP address and host name information simultaneously so that the camera can be detected even in an environment without a DNS server.

In the factory default settings, the setting of [mDNS] is enabled, but to prevent unauthorized use by third parties, disable it after the initial network settings are completed.

RTP (Real-time Transport Protocol)

By using [RTP Server] (P. 60), video and audio data can be delivered to the specified multicast address. It is recommended to set [RTP] to [Disable] when the devices connecting to the camera do not require RTP protocol.

Standard Communication (IP), NDI|HX, RTMP

When using [Standard Communication (IP)] (P. 65), [NDI|HX] (P. 65), and [RTMP] (P. 66), it is possible to distribute videos using each protocol or operate the camera.

If it is unnecessary to connect the camera to a device using these protocols, set each item to [Disable].



Important

- [Video Distribution] under the [User Authority] (P. 72) is not reflected to the RTP.
- When using NDI|HX or RTMP, access control is disabled from the [User Management] (P. 71).

Precautions When Disposing the Camera

When disposing the camera, initialize the camera and delete all setting information such as network settings and administrator account.

For camera initialization, refer to Settings Page (P. 81). When disposing the camera, set [Network Settings] to [Do not save].

If unable to access the Settings Page, use the RESET switch on the camera to restore to the factory default settings.

Encrypting Backup Information

The backup information of the camera settings is used when restoring the camera to the user's previously saved settings. It is possible to manage the backup information more securely by setting [Encryption Password] for the backup information.

Handle the set password with care.

Backup information encryption is set on the camera's Settings Page (P. 83).

Index

A

Administrator	71
Administrator account	72
AE Response	38
AE Shift	38
AF (Auto Focus)	45
AGC Limit	38
Appearance	104
Audio	58
Audio settings (RTP)	60
Authorized user	71
Authorized user account	72
Auto Flip	75
Auto Slow Shutter	39
Autofocus	45
AUX IN	51
AUX OUT	51, 76

B

Backup/Restore	83
Bit Rate Control	57
Black	43

C

Camera housing	12
Camera name	75
Camera Search Tool	16, 26
Certificate Management	69
Color Bars	51, 76
Color Matrix	40, 42
Color Space	42
Connector cover	21
Create certificate	69

D

Date and Time	77
Device information	81
Digital tele-converter	34
Digital zoom	34
DNS	63

E

Encrypted communications	70
--------------------------------	----

Enhanced ND Filter	36
Environment	79
Error log	89
Exposure	35
External Connection (IP)	65
External Connection (Serial)	67

F

Face Detection AF	45
Factory default settings	96, 97
Firewall	25
Flicker Reduction	39
Focus	45
Frame Frequency (Hz)	79
Framerate	56

G

Gain (dB)	38
Gamma	42
General audio	58
Genlock	76
Guest user	71

H

Handle	12
HDMI/SDI	55
Host Access Restrictions	73
HTTP server	59

I

Image quality	42
Image quality details	43
Image Stabilizer	48
Infrared	36
Initial camera settings	26
Initialization	81
Installation conditions	75
IP Audio streaming	58
IP Streaming Video	56
IPv4	62
IPv4 host access restrictions	73
IPv6 host access restrictions	73
Iris (Aperture Value)	36
Iris Limit	38

IS (Image Stabilizer) 48

K

Knee 43

L

LAN 62

Language 80

Lens protector 12

Log messages 89

M

Mainstream 56

Manual Focus 47

mDNS 64

Metering Mode 38

MF (Manual Focus) 47

Microphone 12

N

Names of parts 12

ND Filter 37

NDI|HX 65

Network 62

Noise Reduction 43

Notification log 92

NU 67

O

Operating environment 103

Other functions 51

P

Pan 33

Pan-tilt head 12

POWER lamp 13

Power ON 31

Preset 49

Protocol 67

PTZ 48

R

Receptacle unit 13

Remote Camera Control Application 16

RESET switch 13, 96

RTMP 66

RTP server 60

RTP stream 61

S

SDI 55

Security measures 106

Serial port 67

Server 59

Server certificate 70

Server certificate management 69

Settings Page 30, 31

Sharpness 43

Shooting Mode 35

Shutter Mode 37

Soft Zoom Control 48

Specifications 100

SSL/TLS 70

Standard communication (IP) 65

Standard communication (serial) 68

Standby 31

Substream 1 57

Substream 2 57

System 52

T

Tally lamp 12, 31, 76

Tilt 33

Tripod 21

Troubleshooting 87

U

Update Firmware 84

User authority 72

User Management 71

V

Video Codec 56

Video server 59

Video Size 56

View logs 85

W

Warning log 91

Washer 51

WB (White Balance) 40

White Balance Mode 40

Wiper 12, 51

Z

Zoom	33
------------	----

