



Remote Camera Controller

RC-IP100

User Manual

Make sure to read through this User Manual before using the product.
Regarding the functions changed/added by the latest firmware,
the actual operation and the contents on this document may differ.
Please check the "Updated Information" in this document
for new functions and specification changes.

ENGLISH

Contents

Getting Started

Contents	3
Supplied Accessories	3
Main Features	4
Precautions	4
Name of Parts	5
Preparations	7

Operation

Selecting and Operating a Camera	8
Selecting a Camera	8
Operating a Camera	8
Changing an Assigned Function	9
Selecting a Preset	9
Adjusting the Camera Functions	10
Adjusting Using Function Group Buttons	10
Adjusting Using CAMERA CONTROL	10
Adjusting Using FUNC	10
Tracing	10
Recording Camera Operations (Tracing)	10
Playing Camera Operations (Tracing)	10

Settings

Setup Flow	11
Basic Operations of Menu Screen	11
Menu Screen Flow	12
System Setup	15
Switching the Camera Video Output On/Off	15
Camera Settings Menu	15
Network Settings	16
Camera Network Settings	16
Network Settings on This Controller	16
Tally Setup	17
Tally Control Interface	17

Others

Troubleshooting	18
Third-party Software	18
Connection Diagram	18
Specifications	19

Make sure to read through the “Safety Precautions” items in User Manual (Basic) and make use of the product correctly. After you have finished reading, store the User Manual (Basic) at a place that is readily accessible.

| Content of this Manual

Symbols used

- Caution** : Describes precautions concerning the operation of this product.
- Memo** : Describes reference information, such as functions and usage restrictions of this product.
-  : Indicates the reference page numbers and reference items.

■ Caution

1. Unauthorized reprinting of part or the whole of the contents of this document is strictly forbidden.
2. Contents of the manual may be subject future changes without prior notice.
3. We have taken all possible measures to ensure that the contents in order when creating this manual. However, should you have any comments concerning the information, please contact our customer service center.
4. Notwithstanding 2 and 3 above, we shall not be liable for any impact resulting from the use of this product.

Supplied Accessories

Accessories
Printed Materials
AC Adapter
Power Cord
Wire Clamp
Screw (M3)

Main Features

The following are the features when this unit is used in combination with a remote camera.

| Simple Operation with LCD Touch Panel

Equipped with full color LCD touch panel, which makes operation easy through its versatile screen configuration.

| Operate Camera Freely with Control Lever and Customized Buttons

Equipped with a control lever and customized buttons assignable with functions, which enhances the operability of the camera.

Also enables smooth pan/tilt operation.

| Controls up to 100 remote camera units

This unit can be used to control up to a maximum of 100 remote camera units.

One of the remote cameras can be connected or controlled via serial communication (RS-422).

Precautions

| Storage and Usage Locations

This unit is exclusively designed for in-door use.

Avoid using or placing this unit in the following places.

It might result in malfunctions or failure.

- Hot or cold places that are beyond the allowable operating temperature range (0 °C to 40 °C (32 °F to 104°F)).
- Locations beyond or below the allowable operating humidity range of 20 %RH to 90 %RH. (Condensation is not allowed)
- Near equipment that emits strong magnetic fields, such as transformers or motors.
- Near equipment that emits radio waves, such as transceivers and mobile phones.
- Locations with excessive dust and sand.
- Locations prone to moisture such as window side.
- Locations that are subjected to radiation, X-rays, salt attack or corrosive gases.
- Places subject to smoke or vapor such as near a cooking stove
- Places subject to strong vibrations or unstable surfaces

Do not leave this unit in a parked car under direct sunlight or near a heater for long hours.

Protect this unit against penetration of dust when using it in a place subject to sandy dust.

| Handling Precautions

Do not rub against or press the surface of the touch panel with a knife or a sharp object.

Do not apply excessive force to this unit; do not lift this unit while holding the control lever.

| Maintenance

Turn off the power before performing any maintenance.

Wipe using a soft cloth. Wiping with thinner or benzene may melt or tarnish its surface. For tough stains, wipe using a cloth that is dipped into a neutral detergent diluted with water, followed by wiping with a dry cloth.

| Cautions on Installing this Unit on a Desktop

Install this unit such that it does not fall from the desktop due to vibrations.

| Energy Saving

When this unit is not in use, set the Power switch to “OFF” to reduce power consumption.

| Trademark

Product names and company names indicated in this manual are trademarks or registered trademarks of the respective companies.

| Disclaimer

Do not use any AC adapter other than the AC adapter that comes bundled with this product.

The bundled AC adapter and power cord are to be used with this product only. They cannot be used with other equipment.

| Disposal

When disposing of this product, do so appropriately by following the applicable laws, regulations and local laws.

Name of Parts

| Front Panel

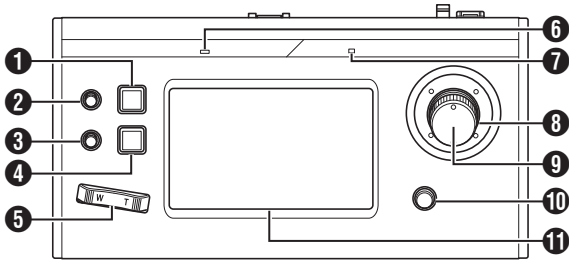

- 1** USER1 button
For configuring the assigned features.
- 2** F1 knob
For adjusting the assigned features.
- 3** F2 knob
For adjusting the assigned features.
- 4** USER2 button
For configuring the assigned features.
- 5** Zoom lever
For performing the zoom operation of the remote camera.
- 6** ALARM lamp
Red : Lights up when the alarm is activated.
- 7** POWER lamp
Green : Lights up while the power is turned on.
- 8** Control lever
For operating pan/tilt of the remote camera.
- 9** F3 knob
For adjusting the assigned features.
- 10** F4 knob
For adjusting the assigned features.
- 11** Operation panel
Used as a touch panel.

Memo : _____
 • For details on how to assign a function to a button or knob, please refer to the following.
 (P9 “Changing an Assigned Function”)

| Rear Panel

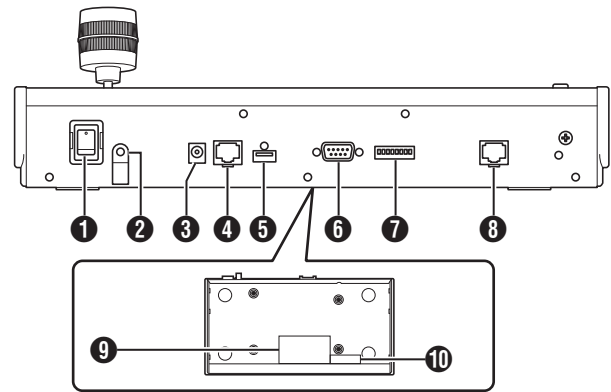

- 1** Power switch
For turning the power on or off.
- 2** Wire Clamp
For preventing the AC adapter cable from falling out.
- 3** DC 12V terminal
For connecting the supplied AC adapter.
- 4** LAN terminal
For connecting a LAN cable.
- 5** SERVICE terminal
For use during servicing.
- 6** TALLY terminal
Used for TALLY connection.
- 7** SETTING switch
1 to 4 : For switching TALLY IN and OUT.
5 to 8 : Used for servicing only.
- 8** SERIAL terminal
For connecting a serial cable.

Memo : _____
 • The specifications of the terminals are as follows.

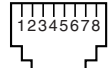

Pin No.	Signal	Pin No.	Signal
1	TX+	5	NC
2	TX-	6	RX-
3	RX+	7	GND
4	NC	8	GND

- 9** Rating label
- 10** MAC address label

| Installing the Wire Clamp

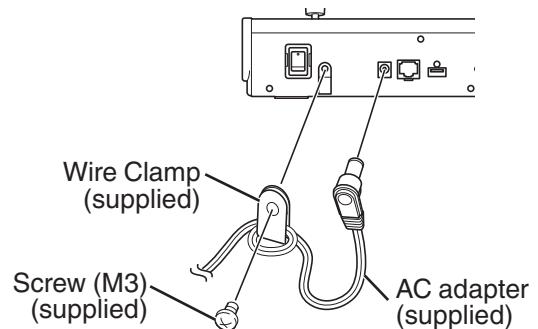

Camera Operation Screen

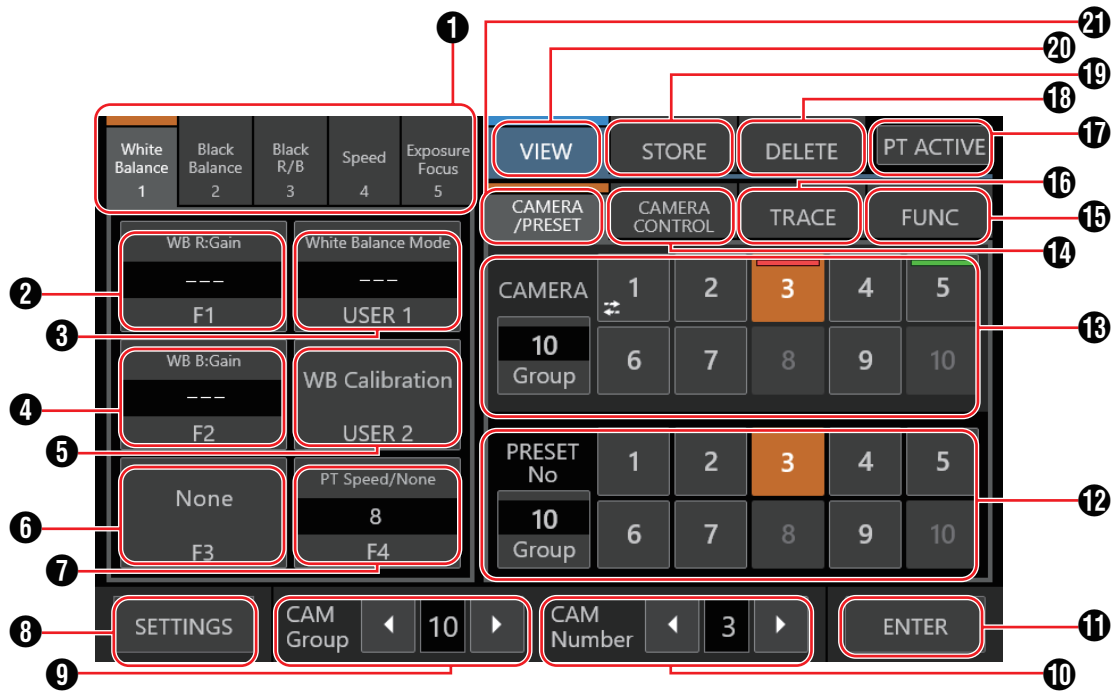

- 1 [Function Group Button]**
Assigns a combination of the preconfigured functions as a function group to a button or knob.
(☞ P10 “Adjusting Using Function Group Buttons”)
 - White Balance
 - Black Balance
 - Black R/B
 - Speed
 - Exposure/Focus
- 2 [F1]**
The function assigned to the F1 knob can be configured. The default function assigned is “Focus”.
- 3 [USER1]**
The function assigned to the USER1 button can be configured. The default function assigned is “One Shot AF”.
- 4 [F2]**
The function assigned to the F2 knob can be configured. The default function assigned is “Iris”.
- 5 [USER2]**
The function assigned to the USER2 button can be configured. The default function assigned is “Shooting Mode”.
- 6 [F3]**
The function assigned to the F3 lever can be configured. The default function assigned is “None”.
- 7 [F4]**
The function assigned to F4 knob can be configured. The default function assigned is “PT Speed/None”.
- 8 [SETTINGS]**
Tap the button to display the SETTINGS screen.

- 9 [CAM Group]**
The camera group can be altered using the left/right buttons.
- 10 [CAM Number]**
The camera number can be altered using the left/right buttons.
- 11 [ENTER]**
For use in the [STORE] mode and [DELETE] mode. Can be used to confirm and delete the preset number.
- 12 [Preset No./Preset Group] button**
A preset number or preset group can be selected. To change the preset group, tap the [Group] button. While the button is lit, tap one of the Preset Group buttons (1 to 10) to change the preset group. Tap the [Group] button again. When the light of the button goes off, the preset number can be changed.
- 13 [Camera No./Camera Group] button**
A camera number or camera group can be selected. To change the camera group, tap the [Group] button. While the button is lit, tap one of the Camera Group buttons (1 to 10) to change the camera group. Tap the [Group] button again. When the light of the button goes off, the camera number can be changed.
Tally light status
PGM : Red
PST : Green
Cameras that are disconnected are indicated by a icon.

Memo : _____

- Up to 10 cameras can be configured to one camera group.
- Up to 10 camera groups can be registered and a total of up to 100 cameras can be configured.

- 14 [CAMERA CONTROL]**
For controlling the currently selected camera.
- 15 [FUNC]**
For changing the settings of the currently selected camera.
- 16 [TRACE]**
For recording the camera operations of the currently selected camera to replicate the operations at a later time.
- 17 [PT ACTIVE]**
Tap the button to switch [PT ACTIVE] on and off. Switching to off disables the pan/tilt operation by the control lever.
- 18 [DELETE]**
Tap the button to enter [DELETE] mode.
- 19 [STORE]**
Tap the button to enter [STORE] mode.
- 20 [VIEW]**
Tap the button to enter [VIEW] mode.
- 21 [CAMERA/PRESET]**
For selecting a camera number or preset number.

Preparations

1 Set the power switch to “On”.

- The power is turned on and the POWER lamp lights up.
- The start screen is displayed on the operation panel. The ALARM lamp lights up at the same time. During which, this unit cannot be operated.
- The start screen disappears after about 10 seconds and the home screen is displayed.

2 Configure the settings of this unit.

- Set the IP address of this unit as follows.
 - ① Select [SETTINGS] on the home screen of the operation panel.
 - If the home screen does not appear, select [HOME] to display the home screen.
 - ② Select [Network].
 - ③ Select [CONTROLLER].
 - The IP address setting screen appears.
 - ④ Enter the IP address and tap [ENTER].

3 Configure the camera settings.

- Configure the camera to be operated as follows.
 - ① Select [SETTINGS] on the home screen of the operation panel.
 - If the home screen does not appear, select [HOME] to display the home screen.
 - ② Select [Network].
 - ③ Select [CAMERA REGISTRATION].
 - ④ Perform registration according to the camera to be connected.
 - IP camera: Select [AUTO] or [Manual]
 - Serial camera: Select [Serial Activate 1] or [Serial Activate 100]

Memo : _____

- For details on the settings, please refer to “Camera Network Settings” (P 16).
- To add or change the camera to be operated, perform the above procedures again.

Selecting and Operating a Camera

| Selecting a Camera

Follow the steps below to specify a camera number and select a camera to operate.

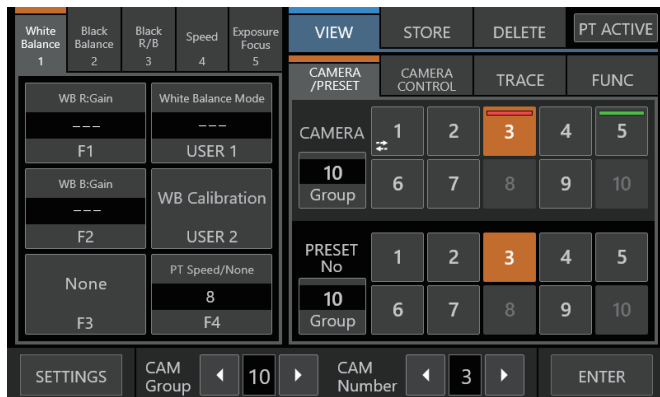

- 1 Display the home screen.**
If the home screen does not appear, tap the [HOME] button on the screen.
- 2 Tap the left/right buttons of [CAM Group] at the bottom of the operation panel to select a camera group.**
- 3 Tap the left/right buttons of [CAM Number] at the bottom of the operation panel to select a camera number.**

Memo : _____

- [Camera Number/Camera Group] under the [CAMERA/PRESET] tab can also be used to select a camera using the following steps.
 - Tap [Group] to light up the button, followed by selecting a group number.
 - Tap the [Group] button again to turn off the button's light, followed by tapping a camera number.

| Operating a Camera

Operating the PTZ (pan/ tilt/ zoom)

- 1 Select a camera to operate.**
(☞ P8 "Selecting a Camera")
- 2 Tilt the control lever toward the direction you want the camera to move (pan/ tilt operation).**
 - Tilt the lever to the left and right to move horizontally (pan) and tilt it up and down to move vertically (tilt).
 - The speed of the pan/tilt operation can be adjusted using the F1/F2/F4 knobs.
(☞ P9 "Changing an Assigned Function")
 - The movement speed changes depending on the tilt angle of the lever.
- 3 Operate the zoom lever to adjust the size of the field of view (zoom operation).**
 - Press the T-end of the lever to magnify the subject (Telephoto) and press the W-end to make the subject appear smaller (Wide-angle).
 - The zoom speed changes according to the extent the zoom lever is being pushed.
 - Zoom operation can also be performed by assigning the F3 knob with the "ZOOM" function.
(☞ P9 "Changing an Assigned Function")
 - The zoom movement speed changes depending on the angle of rotation of the lever.

Performing focus operation

- 1 Set the focus mode to "MF".**
Assign the USER1 or USER2 button with "Focus Mode", followed by tapping the button to switch to MF.
(☞ P9 "Changing an Assigned Function")
- 2 Turn the F1 knob.**
Turn counterclockwise : Focus on near objects.
Turn clockwise : Focus on distant objects.

Memo : _____

- The F2, F3 or F4 knob can also be assigned with the focusing function.
(☞ P9 "Changing an Assigned Function")

One-Shot AF

Tapping the F4 knob performs focusing automatically. The focus mode switches to MF.

Memo : _____

- The F4 knob needs to be assigned with "Focus/One Shot AF".

Changing an Assigned Function

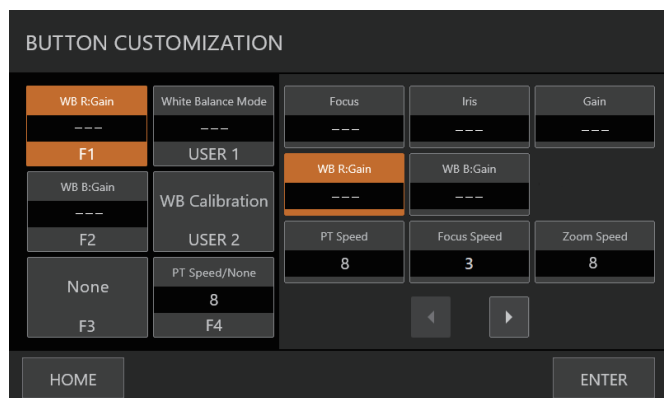

Functions assigned to a knob or button can be changed. The following describes the steps to assign the F1 knob with “Focus” and the USER1 button with “Focus Mode”.

- 1 Select [F1] on the operation panel.
- 2 Select “Focus” from the function selection area on the right side of the screen.
If the function you want to select is not displayed, tap to jump to the next page.
- 3 Select [USER1] on the operation panel.
- 4 Select “Focus Mode” from the function selection area on the right side of the screen.
If the function you want to select is not displayed, tap to jump to the next page.
You can switch between “AF” and “MF” focus using the USER1 button. Setting focus to “MF” allows you to adjust the focus using the F1 knob.
- 5 Tap the [ENTER] button.
Tapping the [ENTER] button confirms the selected setting and returns the display to home screen. Tapping the [HOME] button cancels the selected setting and returns the display to home screen.

Memo : _____

- The functions that can be assigned to each button or knob are as follows. Some functions might not be configurable depending on the camera to be connected, and the menus cannot be operated in this case.
 - F1/F2
Focus, Iris, Gain, WB R : Gain, WB B : Gain, PT Speed, Focus Speed, Zoom Speed, Shutter Speed, Clear Scan, Slow(Second), AGC Limit, AE Shift, Color Temperature, R Gain, B Gain, Sharpness : Level, Sharpness : Limit, Noise Reduction, Knee : Slope, Knee : Point, Knee : Saturation, Master Pedestal, Master Black R, Master Black B, Black Gamma Level, Black Gamma Range, Black Gamma Point, Color Matrix : Gain, Color Matrix : Phase, Color Matrix : R-G, Color Matrix : G-R, Color Matrix : B-R, Color Matrix : R-B, Color Matrix : G-B, Color Matrix : B-G
 - F3
Zoom, Iris, Focus, None
 - USER1/USER2
Shooting Mode, Iris, Shutter Mode, Gain, ND Filter, Metering Mode, None, One Shot AF, Focus Mode, White Balance Mode, WB Calibration, Rec, Preset Color Settings, Gamma, Color Space, Color Matrix, HLG Color, Noise Reduction, Knee-Activate, Knee-Automatic
 - F4
Focus/One Shot AF, PT Speed/None

Selecting a Preset

- What is preset?
This system allows multiple shooting positions and settings to be registered for one camera. Such a registered shooting position or setting is referred to as a “preset”. Up to 100 presets can be registered for a remote camera. This product manages the presets by dividing them into 10 groups. For example, the first preset of the camera corresponds to the first preset of Group 1 on this product, while the 11th preset corresponds to the first preset of Group 2.

Selecting a Preset

Follow the steps below to specify a preset number for retrieving the corresponding camera shooting position or setting.

- 1 Select a camera to operate.
(P8 “Selecting a Camera”)
- 2 Tap the [VIEW] button on the operation panel.
- 3 Select the [CAMERA/PRESET] tab.
- 4 Tap [Group] of [Preset No./Preset Group] to light up the button, followed by selecting a group number.
- 5 Tap the [Group] button again to turn off the button’s light, followed by tapping a preset number.
The registered shooting position or setting is being retrieved.

Memo : _____

- The number of the button is displayed in white if a preset number is registered to it.

Registering a Preset

- 1 Select a camera to operate.
(P8 “Selecting a Camera”)
- 2 Tap the [STORE] button on the operation panel.
- 3 Select the [CAMERA/PRESET] tab.
- 4 Tap [Group] of [Preset No./Preset Group] to light up the button, followed by selecting a group number.
- 5 Tap the [Group] button again to turn off the button’s light, followed by tapping a preset number.
- 6 Tap the [ENTER] button.
The current shooting position or setting is registered to the preset number of the selected preset group.

Deleting a Registered Preset

- 1 Select a camera to operate.
(P8 “Selecting a Camera”)
- 2 Tap the [DELETE] button on the operation panel.
- 3 Select the [CAMERA/PRESET] tab.
- 4 Tap [Group] of [Preset No./Preset Group] to light up the button, followed by selecting a group number.
- 5 Tap the [Group] button again to turn off the button’s light, followed by tapping a preset number.
- 6 Tap the [ENTER] button.
The registration information of the selected preset number of the preset group is deleted.

Adjusting the Camera Functions

| Adjusting Using Function Group Buttons

1 Tap the Function Group button.

Functions with a preconfigured combination are assigned to the buttons and knobs.

For example, by tapping the [White Balance] button, the [USER1] button can be used to toggle the white balance setting between “AWB”/“Daylight”/“Tungsten”/“Kelv”/“Manual”/“SetA”/“SetB”.

Tapping the selected Function Group button again clears the function group selection.

Function Group Button	Default Setting
White Balance	F1: WB R:Gain, F2: WB B:Gain, F3: None, F4: PT Speed/None, USER1: White Balance Mode, USER2: WB Calibration
Black Balance	F1: Master Pedestal, F2: Black Gamma Level, F3: None, User1: None, User2: None, F4: PT Speed/None
Black R/B	F1: Master Black R, F2: Master Black B, F3: None, User1: None, User2: None, F4: PT Speed/None
Speed	F1: Focus Speed, F2: Zoom Speed, F3: None, User1: None, User2: None, F4: PT Speed/None
Exposure/Focus	F1: Focus, F2: Iris, F3: None, User1: One Shot AF, User2: Shooting Mode, F4: PT Speed/None

2 To change the function, tap the corresponding button on the operation panel to select a function, followed by tapping the [ENTER] button.

| Adjusting Using CAMERA CONTROL

1 Select a camera to operate.

(P8 “Selecting a Camera”)

2 Tap the [CAMERA CONTROL] tab.

3 Adjust the Functions.

The adjustable items are as follows. Note that some items might not be adjustable depending on the camera that is connected.

[White Balance], [Gain], [Shutter], [Iris] (AUTO ON/OFF), [Focus] (AUTO ON/OFF), [ND], [Sharpness]

| Adjusting Using FUNC

1 Select a camera to operate.

(P8 “Selecting a Camera”)

2 Tap the [FUNC] tab.

3 Adjust the Functions.

If the function you want to select is not displayed, tap ◀ ▶ to jump to the next page.

The adjustable items are as follows. Some menu items may not be adjustable depending on the camera that is connected.

Digital Zoom, D.Tele-Converter, Soft Zoom Control, PT Acceleration, Image Stabilizer, Focus limit, AF Mode, Face Detection AF, AF Speed, AF Response, AWB Response, AE Response, ND Filter Mode, Auto Slow Shutter, Flicker Reduction, IR Cut Filter, Wiper, Washer, AUX1, AUX2, AUX3, AUX4

Tracing

| Recording Camera Operations (Tracing)

1 Select a camera to operate.

(P8 “Selecting a Camera”)

2 Tap the [STORE] button on the operation panel.

3 Tap the [TRACE] tab and select a number.

4 Tap the [Start Rec] button and operate the camera.

5 Tap the [Stop Rec] button to register the operations.

Memo : _____

- This function is only supported on IP cameras.
- Tapping the [Cancel] button while recording is in progress erases the trace record.

| Playing Camera Operations (Tracing)

1 Select a camera to operate.

(P8 “Selecting a Camera”)

2 Tap the [VIEW] button on the operation panel.

3 Tap the [TRACE] tab and select a number.

4 Tap the [Prepare Trace] button to shift to the position to start tracing.

5 Tap the [Execute Trace] button to execute tracing.

Memo : _____

- Tapping the [Cancel] button stops the tracing process.
- Selecting the number in the [DELETE] tab and tapping [ENTER] erases the recorded trace.

Setup Flow

When setting up the system for the first time, or when new cameras are added, set up in the manner as follows. Be sure to perform an operation check after the setup.

1 IP address settings

Configure the IP address of the connected device according to the system configuration.
(☞ P16 “Network Settings”)

2 Camera setup

Set up the connected camera.
(☞ P15 “Camera Settings Menu”)

3 Remote control settings

For configuring the functions to be assigned to the buttons and knobs of this unit.
(☞ P9 “Changing an Assigned Function”)

Basic Operations of Menu Screen

- 1 Tap the [SETTINGS] button on the home screen.
The settings menu appears.
- 2 Select the item to be configured.

| Settings Menu

- Video
Allows you to switch the video outputs of the connected cameras on or off.
(☞ P15 “Switching the Camera Video Output On/Off”)
- MENU Control
Allows you to display and operate the settings menu of the selected camera.
(☞ P15 “Camera Settings Menu”)
- Function
Allows you to configure the settings for this unit.
 - Touch Screen Volume
Allows you to configure the operation sound of the operation panel.
 - Brightness
Allows you to configure the brightness of the operation panel.
 - Power Save
Allows you to configure the duration of time before this unit enters into power save mode.
Tapping the operation panel while in the Power Save mode exits the mode.
Power save mode is disabled while the settings menu screen is displayed.
 - Default Setting
Allows you to restore the default settings of this unit.
Tapping the button changes the button color. Tap the [ENTER] button in this condition and then turn off the power to restore the default settings.
 - Default Setting User
Initializes the function that is assigned to a button.
Tapping the button changes the button color. Tapping the [ENTER] button in this state executes initialization and displays “Completed”. Tap the [Close] button to complete the configuration.
 - Setting Data<->USB
Allows you to write the settings of this unit to a USB drive and vice versa.
Connect the USB drive to the SERVICE terminal on the rear panel of this unit.

Memo : _____

- Format the USB drive with FAT32/16 in advance. This unit does not support formatting.

- Network
Allows you to configure settings related to the network.
(☞ P16 “Network Settings on This Controller”)
- Touch Screen
Allows you to calibrate the operation panel.
Tapping the [Touch Screen] button displays the adjustment screen. Operate according to the on-screen instructions.

Menu Screen Flow

■ The menu screens consist of normal menu screen and settings menu screen. The flow of the each screen is as shown in the figures below.

| Normal Menu Screen

VIEW Screen

This screen is used for selecting a camera, selecting a camera preset, operating a camera and performing tracing.

Home Screen

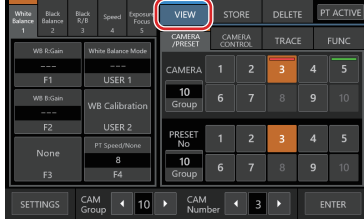

VIEW Screen

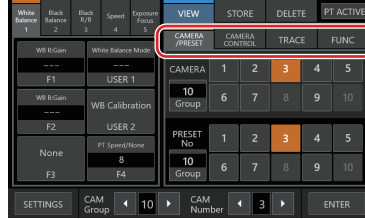

CAMERA/PRESET Screen

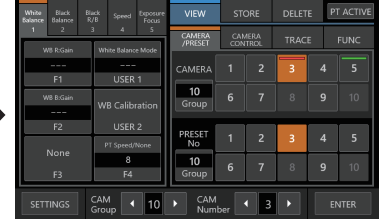

CAMERA CONTROL Screen

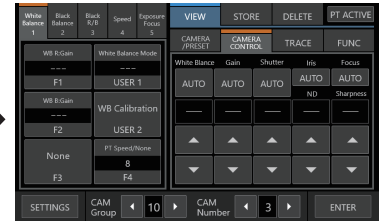

TRACE Screen

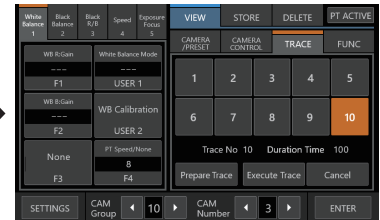

FUNC Screen

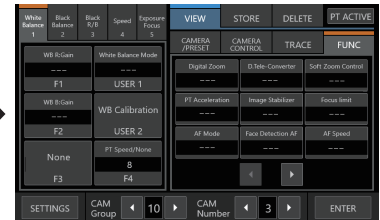

STORE Screen

This screen is used for registering a camera preset or tracing.

Home Screen

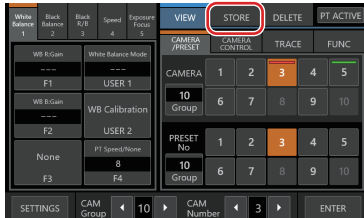

STORE Screen

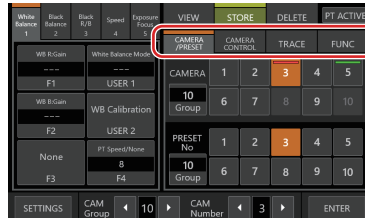

CAMERA/PRESET Screen



TRACE Screen

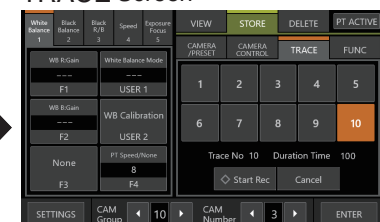

DELETE Screen

This screen is used for deleting a camera preset or tracing.

Home Screen

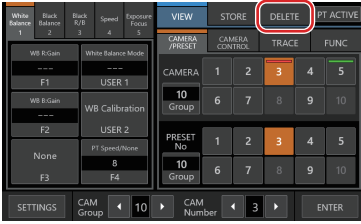

DELETE Screen

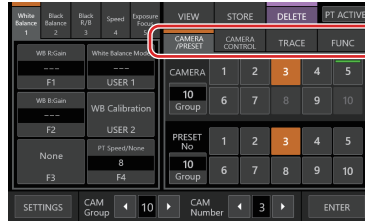

CAMERA/PRESET Screen

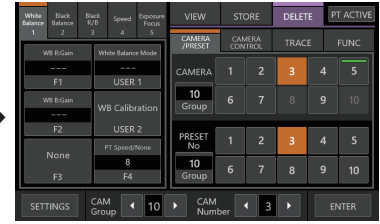

TRACE Screen

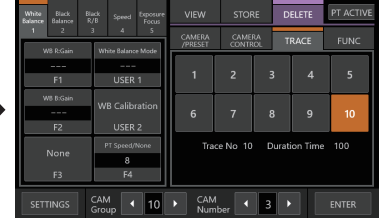

BUTTON CUSTOMIZATION Screen

For assigning functions to the buttons and knobs of this unit.

Home Screen

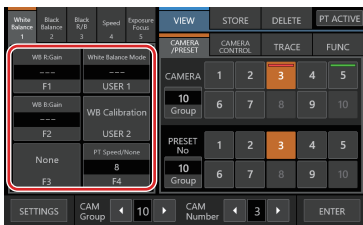

BUTTON CUSTOMIZATION Screen (*)

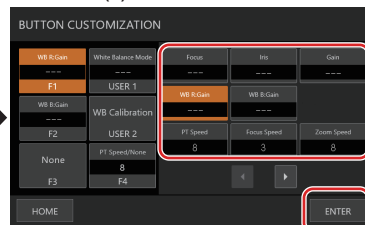

Home Screen

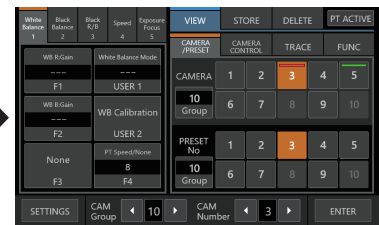

* You can adjust the function that is highlighted without tapping [ENTER] while the screen is displayed.

| Settings Menu Screen

SETTINGS Screen

For configuring the settings of this unit. Tap the [Back] button at the top right corner of the screen to return to the previous screen. Tap the [HOME] button at the bottom left corner of the screen to return to the home screen.
 (P11 "Settings Menu")

Settings

Home Screen

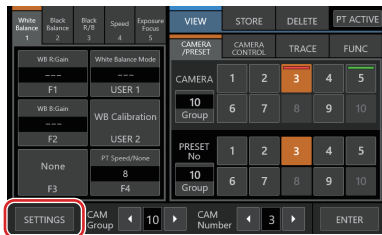

SETTINGS Screen

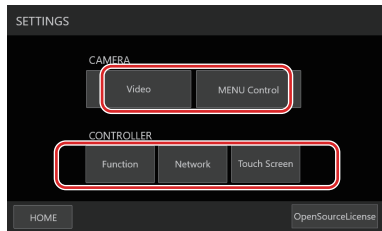

Video Screen

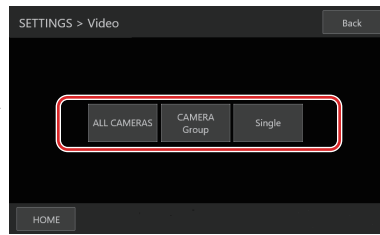

ALL CAMERAS Screen

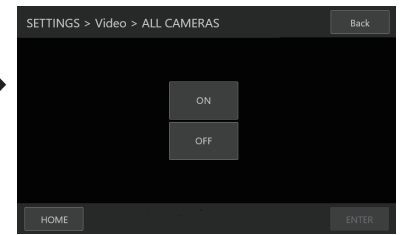

MENU Control Screen

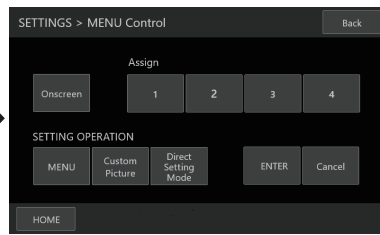

CAMERA Group Screen

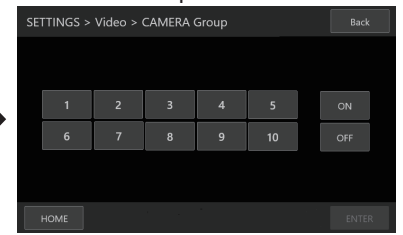

Function Screen

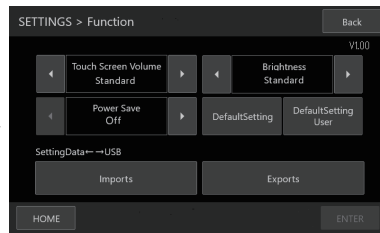

Single Screen

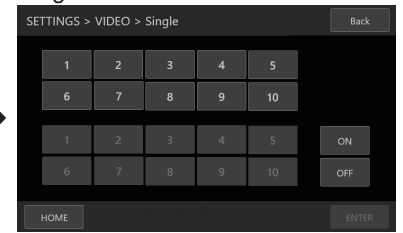

Network Screen

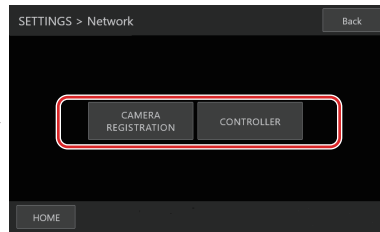

CAMERA REGISTRATION Screen

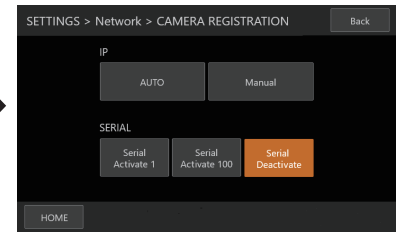

Touch Screen Screen

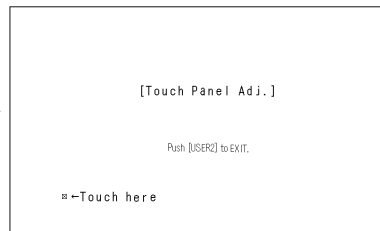

CONTROLLER Screen

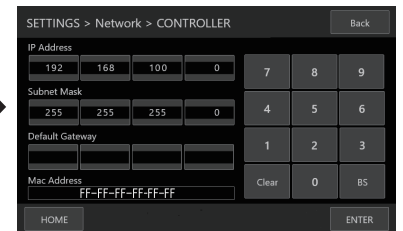

System Setup

Switching the Camera Video Output On/Off

Toggles the video output of the camera between on and off. For some cameras, it is used to switch the camera between the power-on and standby states.

Setting the video outputs of all cameras on/off

- 1 Display the home screen.**
If the home screen does not appear, tap the [HOME] button on the screen.
- 2 Tap the [SETTINGS] button.**
The SETTINGS screen appears.
- 3 Tap the [Video] button.**
- 4 Tap the [ALL CAMERAS] button.**
- 5 Tap the [ON] or [OFF] button.**
 - Tapping the button changes the button color.
 - Tap the [ON] button to set the video output of the camera to on.
Tap the [OFF] button to set the video output of the camera to off.
- 6 Tap the [ENTER] button to confirm the setting.**

Setting the video outputs of camera groups on/off

- 1 Display the home screen.**
If the home screen does not appear, tap the [HOME] button on the screen.
- 2 Tap the [SETTINGS] button.**
The SETTINGS screen appears.
- 3 Tap the [Video] button.**
- 4 Tap the [CAMERA Group] button.**
- 5 Tap the number button corresponding to the number of the camera group to be configured.**
 - Multiple camera groups can be selected.
 - The digit of the number with non-existent camera within the camera group is displayed in white.
- 6 Tap the [ON] or [OFF] button.**
 - Tapping the button changes the button color.
 - Tap the [ON] button to set the video output of the camera to on.
Tap the [OFF] button to set the video output of the camera to off.
- 7 Tap the [ENTER] button to confirm the setting.**

Setting the video output of individual camera on/off

- 1 Display the home screen.**
If the home screen does not appear, tap the [HOME] button on the screen.
- 2 Tap the [SETTINGS] button.**
The SETTINGS screen appears.
- 3 Tap the [Video] button.**
- 4 Tap the [Single] button.**
- 5 Tap the number button corresponding to the number of the camera group to be configured.**
The digit of the number with non-existent camera within the camera group is displayed in white.

- 6 Tap the number button corresponding to the number of the camera to be configured.**
 - Multiple cameras within the same group can be selected.
 - Numbers that do not correspond to any of the existing cameras are indicated in white.
- 7 Tap the [ON] or [OFF] button.**
 - Tapping the button changes the button color.
 - Tap the [ON] button to set the video output of the camera to on.
Tap the [OFF] button to set the video output of the camera to off.
- 8 Tap the [ENTER] button to confirm the setting.**

Memo : _____

- [ALL CAMERAS] can be configured to "ON"/"OFF" only for cameras within the same network.
- To control the Video output of a camera that is not within the same network, use CAMERA Group or Single.
- When the video output of a camera is turned off, you will not be able to control the camera.

Camera Settings Menu

Making changes to the settings menu of the camera

- 1 Tap the [SETTINGS] button on the home screen of the operation panel.**
 - The SETTINGS screen appears.
 - If the home screen does not appear, select [HOME] to display the home screen.
- 2 Tap the [MENU Control] button on the SETTINGS screen.**
- 3 Make changes to the settings menu of the camera.**
 - You can use the operation panel buttons to select a function and use the control lever and buttons to change the setting.

Buttons	Functions
Onscreen	Toggles the on-screen display between on and off
MENU	Toggles the menu display between on and off when the on-screen display is on
Custom Picture	Toggles the customized picture menu between on and off when the on-screen display is on
Direct Setting Mode	For selecting a Camera Direct setting when the on-screen display is on
Assign 1 to 4	Executes the function assigned to the Assign button
ENTER	Confirms an operation
Cancel	Cancels an operation

- 4 Tap the [HOME] button.**
 - After changing the settings, tap the [HOME] button to return to the home screen.
- Memo : _____
- Some cameras might not allow operation of the menu.
 - For details on making changes to the settings menu of the camera, please refer to the User Manual of the camera.
 - When removing the camera from the network, delete the camera registration as well.

Network Settings

| Camera Network Settings

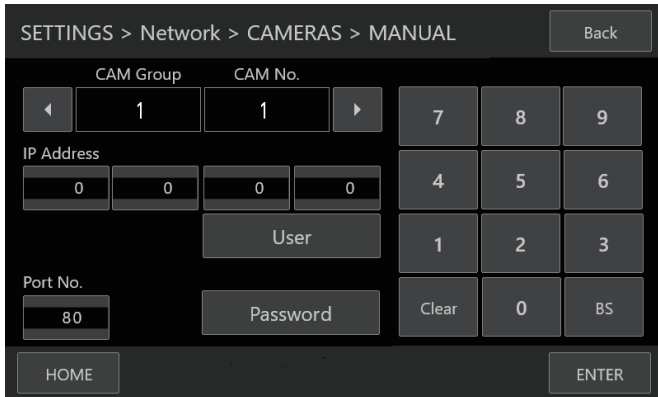

1 Display the home screen.

If the home screen does not appear, tap the [HOME] button on the screen.

2 Tap the [SETTINGS] button.

The SETTINGS screen appears.

3 Tap the [Network] button.

4 Tap the [CAMERA REGISTRATION] button.

5 Tap the button corresponding to the camera to be connected.

■ IP Camera [AUTO]

Tapping the [AUTO] button displays a message.

Tapping the [ENTER] button automatically registers up to 10 cameras that can be operated without user authentication and displays the “Completed” message. Tap the [Close] button to complete the configuration.

■ IP Camera [Manual]

Tapping the [Manual] button displays the manual settings screen for IP address.

- Tap the left/right buttons to select a registered [CAM Group] and [CAM No.].
- Enter the IP address using the numeric keypad.
- Configure [Port No.], [User] and [Password].
- Tap the [ENTER] button to confirm the entered values.
- Configure all the cameras to be registered using the same procedures.

Memo : _____

- This is a function to register the IP address of the camera to this unit. The IP address of the camera unit cannot be changed even when performing manual registration by selecting [Manual].
- Use the same [Port No.], [User] and [Password] as configured on the connected camera.
- Configuring the IP address to “0.0.0.0” deletes the registration of that camera.
- Numbers corresponding to a serial camera cannot be registered.

- [Serial Activate 1] and [Serial Activate 100] Serial Cameras
- Serial cameras can be registered to <1-1> or <10-10>. (<Camera Group No.-Camera No.>)
- Tap [Serial Activate 1] to register to <1-1> and tap [Serial Activate 100] to register to <10-10>.
- “Completed” appears when connection is established. Upon tapping the [Close] button, configuration is complete and the button color changes.

Memo : _____

- Serial cameras cannot be registered to buttons corresponding to a number that is registered with an IP camera.

■ [Serial Deactivate] Serial Camera Deactivation

To deactivate the use of a serial camera, select [Serial Deactivate].

| Network Settings on This Controller

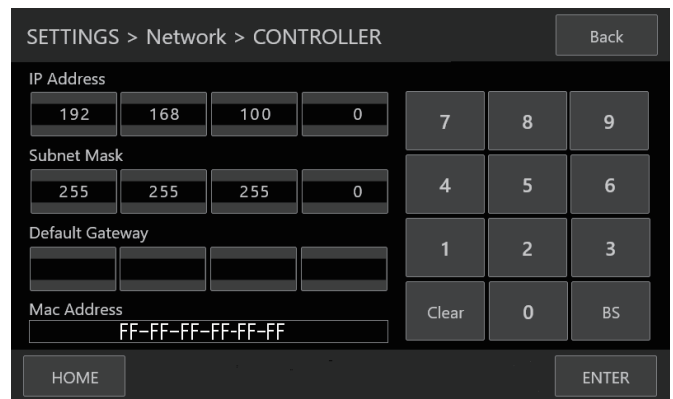

1 Display the home screen.

If the home screen does not appear, tap the [HOME] button on the screen.

2 Tap the [SETTINGS] button.

The SETTINGS screen appears.

3 Tap the [Network] button.

4 Tap the [CONTROLLER] button.

The network settings screen of this unit appears.

5 Enter each item and tap the [ENTER] button.

Memo : _____

- The default IP address of this unit is 192.168.100.0.

Tally Setup

Tally Control Interface

Configure the pin 4 and pin 5 functions of the tally terminal using the SETTING switch on the rear panel.



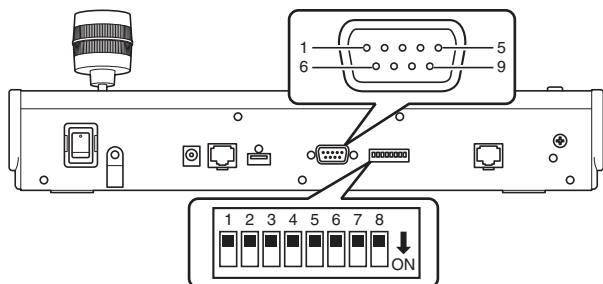

Other than pin 4 and pin 5, the remaining pin functions cannot be changed.

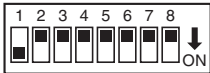

Memo :

- If a camera has been selected to receive tally signals, the button corresponding to the camera appears like .

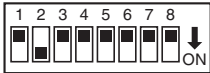
Configuration method

Tally terminal pin number	Function	SETTING switch
1	INPUT-1	-
2	INPUT-2	-
3	INPUT-3	-
4	INPUT-4	
	OUTPUT-5	
5	INPUT-5	
	OUTPUT-4	
6	GND	-
7	OUTPUT-1	-
8	OUTPUT-2	-
9	OUTPUT-3	-

Memo :

- The tally input or tally output supports camera number 1 to 5 of camera group 1. To use the tally input or tally output, assign the cameras to these numbers. For details on the tally input and tally output, refer to the "Function" column of "Configuration method".
- Inserting and removing of the tally terminal should be performed while the power is turned off.

Connection example for TALLY OUT

Please ensure the following conditions are met.

Voltage : Maximum DC 24 V

Current : Maximum 50 mA

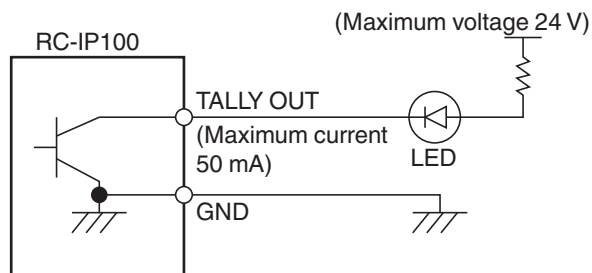

Connection example for TALLY IN

Set up the contact input.

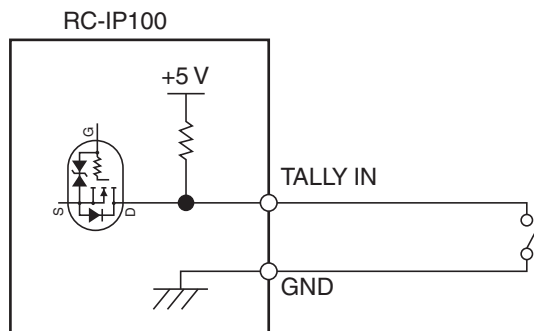

Troubleshooting

Problem	Symptom	Action
Power does not turn on.	No response even after tapping the operation panel on the unit.	Turn off the power switch at the back of the unit and power on again. If it still does not start up, stop using the unit, disconnect the power cord from the power outlet and consult a dealer or our service center.

Third-party Software

This product includes third-party software modules. For the licensing terms of the respective modules, please refer to [HOME]>[SETTINGS]>[Open Source License].

Connection Diagram

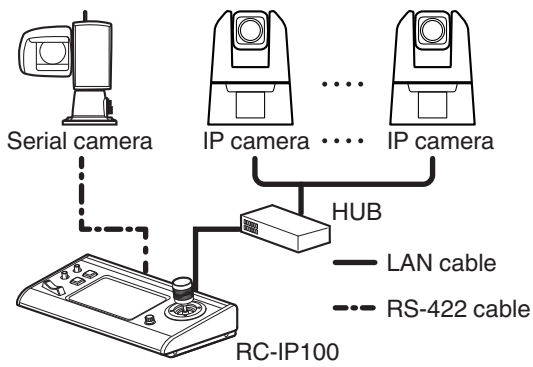

* Up to 100 cameras can be connected concurrently.

Specifications

For the latest information on the product (firmware, User Manual, etc.), please visit our website.

General

Item	Description
Power	DC 12 V
Current consumption	0.6 A
Mass	Approx. 2.1 kg
Surrounding temperature	0 °C to 40 °C (32 °F to 104 °F) (operation)
Allowable operating humidity	20 %RH to 90 %RH (No condensation)

Terminal Section

Item	Description
TALLY terminal	D-sub 9-pin
LAN terminal	10BASE-T/100BASE-TX
DC 12V terminal	DC jack (for the supplied AC adapter)
SERIAL terminal	RS-422

Dimensional Outline Drawing (Unit: mm)

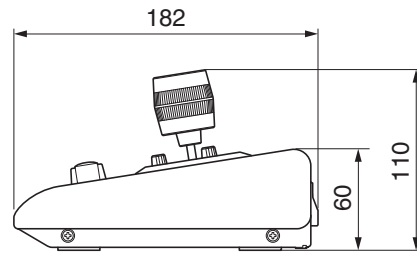
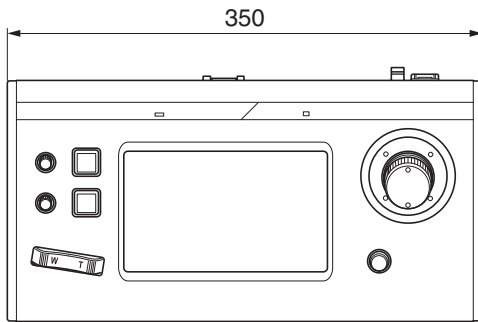

* The specifications and appearance of this product are subject to changes for further improvement without prior notice.

Accessories

Accessories
Printed Materials
AC Adapter
Power Cord
Wire Clamp
Screw (M3)

Compatible Cameras

Please refer to “About Cameras Compatible to the Remote Camera Controller RC-IP100” on the website. Please note that some features might not be usable depending on the camera in use.

Updated Information

The previous pages covers information in Version 1.00. For new features/changes in Version 1.01 and later, read the following.

Version Check and Update

To check the version, select [SETTINGS] > [Function] and check the version information displayed in the upper right corner of the [Function] screen.

If necessary, download the latest firmware from the website and update the firmware of this controller.

Refer to the documentation that came with the firmware to update.

Version 1.01

New features and specification changes are listed below.

- Method for Calling a Preset
- Setting the PT Operation Direction
- Adding Functions that can be Assigned to the Buttons and Knobs
- Changes in the Factory Default Settings

Method for Calling a Preset

When calling a preset, it is now possible to specify the speed level by time or by speed.

■ Calling a Preset

Press the USER1 button to select whether to specify the speed level by time or by speed in [Speed Mode], turn the F1 knob to adjust the value, and then call the preset.

(☞ P9 "Selecting a Preset")

Depending on the relationship between the pan/tilt/zoom position before the call and the registered pan/tilt/zoom position, and the [Time (sec.)] setting, it may not operate within the set time.

■ Stopping a Preset Call

Pressing the USER2 button during preset operation stops the operation.

Setting the PT Operation Direction

It is now possible to change the direction in which the camera moves when using the pan or tilt with the control lever.

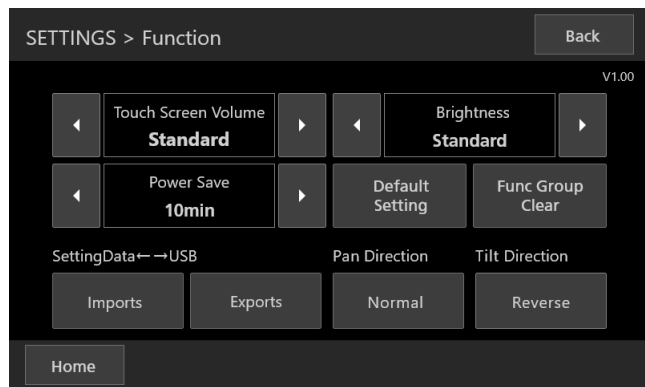

■ Function

- Pan Direction/Tilt Direction

When operating the camera with the control lever, the user can set the direction in which the camera operates when the lever is tilted. When [Pan Direction] is set to [Normal], the camera moves clockwise by tilting the lever to the right. Also, when [Tilt Direction] is set to [Normal], tilting the lever toward the user will tilt the camera forward.

Adding Functions that can be Assigned to the Buttons and Knobs

■ Adding Functions

It is now possible to assign the functions relating to the preset to each button and knob.

- F1/F2/F4
Time (sec.)/Speed
- USER1/USER2
Speed Mode, Stop

Changes in the Factory Default Settings

The values of the factory default settings were changed as follows:

(☞ P6 "Camera Operation Screen")

	Before	After
[F1]	Focus	Time (sec.) / Speed
[F2]	Iris	Zoom Speed
[USER1]	One Shot AF	Speed Mode
[USER2]	Shooting Mode	Stop

Version 1.10

New features and specification changes are listed below.

- Added Adjustable Functions and Changed Item Name in [FUNC]

	Before	After
Added	-	[Enhanced ND Filter] [Color Bars]
Changed item name	[IR Cut Filter]	[Infrared]

Version 1.20

The new functions and specification changes are as follows.

- ISO support [F1,F2,USER1,USER2,CAMERA CONTROL]
- Supports ISO/Gain limit at auto [F1,F2]
- Supports CC settings for WB [F1,F2]
- Adding Custom Picture file select [F1,F2]
- Spatial Filter and Frame Correlation support for NR [F1,F2]
- Adding functions that can be set in [FUNC]
Gain Boost, Face Detection AE, Eye Detection, AWB Lock, Shockless WB
- Adding Shutter [F1,F2]
- MENU Control button added to the assigned function [USER1,USER2]
- Activate can be selected without connecting a serial camera
- BUTTON CUSTOMIZATION screen procedure changes

ISO support [F1,F2,USER1,USER2,CAMERA CONTROL]

[Gain] is changed to [ISO/Gain] and ISO can now be adjusted. Displays the ISO setting status when ISO is used and the Gain setting status when Gain is used, according to the camera settings.

Supports ISO/Gain limit at auto [F1,F2]

AGC Limit can now be controlled when using ISO.

Supports CC settings for WB [F1,F2]

Color Compensation [WB CC] for white balance can now be adjusted.

Adding Custom Picture file select [F1,F2]

Custom picture files can now be selected.

Spatial Filter and Frame Correlation support for NR [F1,F2]

Spatial Filter and Frame Correlation for noise reduction can now be set.

Adding functions that can be set in [FUNC]

The following five functions have been added to [FUNC].

- Gain Boost
- Face Detection AE
- Eye Detection
- AWB Lock
- Shockless WB

(☞ P10 “Adjusting Using FUNC”)

Adding Shutter [F1,F2]

A new function [Shutter] has been added that allows Shutter settings to be made independently of Shutter Mode.

MENU Control button added to the assigned function [USER1,USER2]

When MENU Control is assigned to the USER1 and USER2 buttons, the SETTING screen is omitted and the display shifts to the MENU Control screen. Also, when “Back” is pressed, it returns to the HOME screen.

(☞ P15 “Making changes to the settings menu of the camera”)

Activate can be selected without connecting a serial camera

Serial Activate1 or Serial Activate100 can now be selected without connecting a serial camera.

(☞ P7 “Configure the camera settings.”)

BUTTON CUSTOMIZATION screen procedure changes

After pressing the customized buttons (F1/F2/F3/F4/USER1/USER2), the screen for selecting whether or not to assign a function (“Change Settings?” screen) is now displayed.

(☞ P9 “Changing an Assigned Function”)

Procedure before change	Procedure after change
HOME⇒F1/F2/F3/F4/ USER1/USER2⇒ BUTTON CUSTOMIZATION⇒ ENTER or HOME⇒ Please wait⇒HOME	HOME⇒F1/F2/F3/F4/USER1/ USER2⇒ Change Settings? ⇒ Cancel ⇒HOME or, HOME⇒F1/F2/F3/F4/USER1/ USER2⇒ Change Settings? ⇒ OK ⇒ BUTTON CUSTOMIZATION

[Amendment]

The table in “3 Make changes to the settings menu of the camera.” on page 15 is amended as follows.

Buttons	Features
Onscreen	Toggles the on-screen display between on and off
MENU	Toggles the menu display between on and off
Custom Picture	Toggles the customized picture menu between on and off
Direct Setting Mode	Selects a Camera Direct setting
Assign 1 to 4	Executes the function assigned to the Assign button
ENTER	Confirms an operation
Cancel	Cancels an operation

The functions available on this device may differ depending on the camera and connection method.